



# ServeRAID M5225-2GB SAS/SATA Controller

## User's Guide

Part Number: 00FH245

**Second Edition (December 2015)**

**© Copyright Lenovo 2014, 2015. All rights reserved.**

LIMITED AND RESTRICTED RIGHTS NOTICE: If data or software is delivered pursuant a General Services Administration "GSA" contract, use, reproduction, or disclosure is subject to restrictions set forth in Contract No. GS-35F-05925

---

# Table of Contents

|                                                                                 |           |
|---------------------------------------------------------------------------------|-----------|
| <b>Chapter 1: Overview</b>                                                      | <b>11</b> |
| 1.1 ServeRAID M5225-2GB Controller Description                                  | 11        |
| 1.1.1 Memory Module and Flash Power Module                                      | 11        |
| 1.1.2 Enclosures                                                                | 11        |
| 1.2 Controller Guidelines                                                       | 11        |
| 1.3 MegaRAID Mode                                                               | 12        |
| 1.4 Replaceable Components                                                      | 12        |
| 1.4.1 Summary of RAID Levels                                                    | 13        |
| 1.5 Configuration Scenarios                                                     | 14        |
| 1.5.1 Number of Physical Disks Supported                                        | 15        |
| 1.6 SAS Protocols                                                               | 16        |
| 1.7 Benefits of the SAS Interface                                               | 16        |
| 1.7.1 PCI Express Architecture                                                  | 16        |
| 1.7.2 Operating System Support                                                  | 16        |
| 1.8 Benefits of the ServeRAID M5225-2GB SAS/SATA Controller                     | 17        |
| 1.8.1 SAS Features                                                              | 17        |
| 1.8.2 SAS Drive Group Limitations                                               | 18        |
| 1.8.3 SATA III Features                                                         | 18        |
| 1.8.4 PCI Express Performance                                                   | 19        |
| 1.8.5 Usability Features                                                        | 19        |
| 1.8.6 Flexibility Features                                                      | 19        |
| 1.8.7 CacheCade                                                                 | 19        |
| 1.8.8 Protection Information (T10-DIF)                                          | 20        |
| 1.8.9 Drive Roaming                                                             | 20        |
| 1.8.10 Drive Migration                                                          | 21        |
| 1.8.11 Automatic Rebuilds on New Drives                                         | 21        |
| 1.9 Hardware Specifications                                                     | 22        |
| 1.10 Technical Support                                                          | 22        |
| <b>Chapter 2: ServeRAID M5225-2GB Controller Hardware Installation</b>          | <b>23</b> |
| 2.1 Requirements                                                                | 23        |
| 2.2 Installing the Controller                                                   | 23        |
| 2.3 Installing and Connecting the Flash Power Module                            | 25        |
| 2.4 Connecting a ServeRAID M5225-2GB SAS/SATA Controller to a Storage Enclosure | 27        |
| 2.5 After Installing the Controller                                             | 28        |
| 2.6 Replacing a Full-Profile Bracket with a Low-Profile Bracket                 | 28        |
| <b>Chapter 3: ServeRAID M5225-2GB SAS/SATA Controller Characteristics</b>       | <b>29</b> |
| 3.1 Board Layout and Connector Information                                      | 29        |
| 3.2 Characteristics of the ServeRAID M5225-2GB SAS/SATA Controller              | 31        |
| 3.2.1 Controller Specifications                                                 | 31        |
| 3.2.2 Drive Group Performance Features                                          | 32        |
| 3.2.3 Fault Tolerance                                                           | 32        |
| 3.2.4 Power Supply Requirements for the ServeRAID M5225-2GB SAS/SATA Controller | 33        |
| 3.2.5 Operating and Non-operating Conditions                                    | 33        |
| 3.2.6 Safety Characteristics                                                    | 33        |
| <b>Appendix A: Getting Help and Technical Assistance</b>                        | <b>34</b> |

---

|                                                                              |           |
|------------------------------------------------------------------------------|-----------|
| A.1 Before You Call .....                                                    | 34        |
| A.2 Using the Documentation .....                                            | 35        |
| A.3 Getting Help and Information from the World Wide Web .....               | 35        |
| A.4 Software service and support .....                                       | 36        |
| A.5 Hardware service and support .....                                       | 36        |
| A.6 Taiwan product service .....                                             | 36        |
| <b>Appendix B: Notices .....</b>                                             | <b>37</b> |
| B.1 Trademarks .....                                                         | 38        |
| B.2 Important notes .....                                                    | 38        |
| B.3 Recycling information .....                                              | 39        |
| B.4 Telecommunication regulatory statement .....                             | 39        |
| B.5 Electronic emission notices .....                                        | 39        |
| B.5.1 Federal Communications Commission (FCC) statement .....                | 39        |
| B.5.2 Industry Canada Class A emission compliance statement .....            | 40        |
| B.5.3 Australia and New Zealand Class A statement .....                      | 40        |
| B.5.4 European Union EMC Directive conformance statement .....               | 40        |
| B.5.5 Germany Class A statement .....                                        | 41        |
| B.5.6 Japan VCCI Class A statement .....                                     | 42        |
| B.5.7 Korea Communications Commission (KCC) statement .....                  | 42        |
| B.5.8 Russia Electromagnetic Interference (EMI) Class A statement .....      | 42        |
| B.5.9 People's Republic of China Class A electronic emission statement ..... | 42        |
| B.5.10 Taiwan Class A compliance statement .....                             | 42        |

---

# Safety

Before installing this product, read the Safety Information.

قبل تركيب هذا المنتج، يجب قراءة الملاحظات الأمنية

Antes de instalar este produto, leia as Informações de Segurança.

在安装本产品之前，请仔细阅读 **Safety Information**  
(安全信息)。

安裝本產品之前，請先閱讀「安全資訊」。

Prije instalacije ovog produkta obavezno pročitajte Sigurnosne Upute.

Před instalací tohoto produktu si přečtěte příručku bezpečnostních instrukcí.

Læs sikkerhedsforskrifterne, før du installerer dette produkt.

Lees voordat u dit product installeert eerst de veiligheidsvoorschriften.

Ennen kuin asennat tämän tuotteen, lue turvaohjeet kohdasta Safety Information.

Avant d'installer ce produit, lisez les consignes de sécurité.

Vor der Installation dieses Produkts die Sicherheitshinweise lesen.

Πριν εγκαταστήσετε το προϊόν αυτό, διαβάστε τις πληροφορίες ασφάλειας  
(safety information).

לפני שתתקינו מוצר זה, קראו את הוראות הבטיחות.

A termék telepítése előtt olvassa el a Biztonsági előírásokat!

Prima di installare questo prodotto, leggere le Informazioni sulla Sicurezza.

製品の設置の前に、安全情報をお読みください。

본 제품을 설치하기 전에 안전 정보를 읽으십시오.

Пред да се инсталира овој продукт, прочитајте информацијата за безбедност.

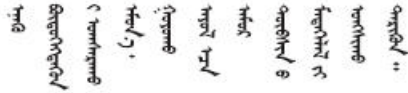

Les sikkerhetsinformasjonen (Safety Information) før du installerer dette produktet.

Przed zainstalowaniem tego produktu, należy zapoznać się z książką "Informacje dotyczące bezpieczeństwa" (Safety Information).

Antes de instalar este produto, leia as Informações sobre Segurança.

Перед установкой продукта прочтите инструкции по технике безопасности.

Pred inštaláciou tohto zariadenia si pečítajte Bezpečnostné predpisy.

Pred namestitvijo tega proizvoda preberite Varnostne informacije.

Antes de instalar este producto, lea la información de seguridad.

Läs säkerhetsinformationen innan du installerar den här produkten.

ཐོན་ཁུངས་འདི་བདེ་སྤྱོད་མ་བྱས་གོང་། སྐྱོར་གྱི་ཡིད་གཟབ་  
བྱ་འདྲ་མིན་ཡིད་བའི་འོད་སྟེར་བལྟ་དགོས།

Bu ürünü kurmadan önce güvenlik bilgilerini okuyun.

مەزكۇر مەھسۇلاتنى ئورنىتىشتىن بۇرۇن بىخەتەرلىك ئۇچۇرلىرىنى ئوقۇپ چىقىڭ.

Youq mwngz yungh canjbinj neix gaxgonq, itdingh aeu doeg aen  
canjbinj soengq cungj vahgangj ancien siusik.

---

## Safety statements

These statements provide the caution and danger information that is used in this documentation.

### **Important:**

Each caution and danger statement in this documentation is labeled with a number. This number is used to cross reference an English-language caution or danger statement with translated versions of the caution or danger statement in the *Safety Information* document.

For example, if a caution statement is labeled "Statement 1," translations for that caution statement are in the *Safety Information* document under "Statement 1."

Be sure to read all caution and danger statements in this documentation before you perform the procedures. Read any additional safety information that comes with your system or optional device before you install the device.

**Statement 1:**



**DANGER**

**Electrical current from power, telephone, and communication cables is hazardous.**

**To avoid a shock hazard:**

- **Do not connect or disconnect any cables or perform installation, maintenance, or reconfiguration of this product during an electrical storm.**
- **Connect all power cords to a properly wired and grounded electrical outlet.**
- **Connect to properly wired outlets any equipment that will be attached to this product.**
- **When possible, use one hand only to connect or disconnect signal cables.**
- **Never turn on any equipment when there is evidence of fire, water, or structural damage.**
- **Disconnect the attached power cords, telecommunications systems, networks, and modems before you open the device covers, unless instructed otherwise in the installation and configuration procedures.**
- **Connect and disconnect cables as described in the following table when installing, moving, or opening covers on this product or attached devices.**

**To Connect:**

1. Turn everything OFF.
2. First, attach all cables to devices.
3. Attach signal cables to connectors.
4. Attach power cords to outlet.
5. Turn device ON.

**To Disconnect:**

1. Turn everything OFF.
2. First, remove power cords from outlet.
3. Remove signal cables from connectors.
4. Remove all cables from devices.



**Statement 3:**



**CAUTION:**

When laser products (such as CD-ROMs, DVD drives, fiber optic devices, or transmitters) are installed, note the following:

- Do not remove the covers. Removing the covers of the laser product could result in exposure to hazardous laser radiation. There are no serviceable parts inside the device.
- Use of controls or adjustments or performance of procedures other than those specified herein might result in hazardous radiation exposure.



**DANGER**

Some laser products contain an embedded Class 3A or Class 3B laser diode. Note the following.

Laser radiation when open. Do not stare into the beam, do not view directly with optical instruments, and avoid direct exposure to the beam.

**Statement 8:**



**CAUTION:**

Never remove the cover on a power supply or any part that has the following label attached.



Hazardous voltage, current, and energy levels are present inside any component that has this label attached. There are no serviceable parts inside these components. If you suspect a problem with one of these parts, contact a service technician.

**Statement 28:**



**CAUTION:**

The battery is a lithium ion battery. To avoid possible explosion, do not burn the battery. Exchange it only with the approved part. Recycle or discard the battery as instructed by local regulations.

---

# Chapter 1: Overview

## 1.1 ServeRAID M5225-2GB Controller Description

The ServeRAID M5225-2GB SAS/SATA controller is a PCI-Express 3.0, low-profile RAID controller based on the LSI SAS3108 PCI Express-SAS/SATA I/O Processor chip. The controller supports eight external SAS/SATA ports through two SFF-8644 HD-4e external connectors. The controller integrates eight high-performance SAS/SATA PHYs and a PCI Express bus master DMA core. Each of the eight PHYs is capable of 12.0 Gb/s SAS link rates and 6.0 Gb/s SATA III link rates.

The controller brings 12.0 Gb/s SAS and 6.0 Gb/s SATA performance to host controller, workstation, and server designs. The controller supports external storage devices, which allows you to use a system that supports enterprise-class SAS drives, and desktop-class SATA drives. The controller can connect to drives directly. Simplified cabling between devices is an additional benefit.

The LSI SAS3108 device increases system performance and provides fault-tolerant data storage. The LSI SAS3108 device supports data striping across multiple disks, which reduces disk access time because multiple disks simultaneously read or write data. In addition, the LSI SAS3108 device backs up data with either data mirroring or a parity block. Either backup method enables you to recover lost data in the event of a disk failure. You can select the data backup method that best suits your needs. A hardware RAID assist exclusive-OR (XOR) engine speeds parity generation and checking and reduces system-access times.

### 1.1.1 Memory Module and Flash Power Module

The ServeRAID M5225-2GB controller supports a Memory Module, a Flash Power Module, and a cable. The Memory Module is an Open NAND Flash Interface (ONFI) flash module that provides cache offload capability to protect cached data in case of host power loss or server failure. The Flash Power Module is a super-capacitor pack that provides power for the backup of your data in case of host power loss or server failure.

The Memory Module is pre-installed on the controller. You can connect the Memory Module by cable to a remote Flash Power Module that is mounted on the system chassis. See [Section 2.3, "Installing and Connecting the Flash Power Module"](#) for instructions on how to install the Flash Power Module and connect it to the Memory Module.

### 1.1.2 Enclosures

You can connect the controller by cable to a storage enclosure. The enclosure can contain SAS drives and SATA drives. See [Section 2.4, "Connecting a ServeRAID M5225-2GB SAS/SATA Controller to a Storage Enclosure"](#) for instruction on how to connect the external connector on the cable to the controller and the storage enclosure:

## 1.2 Controller Guidelines

Before you install the controller, read the following guidelines:

- You can connect only one device per SAS PHY unless you use an expander
- Cables have to meet the SAS specification
- You cannot mix SAS drives and SATA drives in the same virtual drive
- You cannot mix SAS Solid State Drives (SSDs) or SATA SSDs and existing mechanical drives (SAS or SATA) in the same virtual drive
- You cannot mix Solid State SAS drives and Solid State SATA drives in the same virtual drive

See [Section 3.2.4, "Power Supply Requirements for the ServeRAID M5225-2GB SAS/SATA Controller"](#) for information about the power requirements, and [Section 3.2.5, "Operating and Non-operating Conditions"](#) for information about the minimum and the maximum temperature ranges.

## 1.3 MegaRAID Mode

The ServeRAID M5225-2GB controller runs in MegaRAID (MR) mode. The major advantage of MR mode is that it supports more RAID levels than Integrated MegaRAID (iMR) mode. MR mode supports RAID levels 0, 1, 5, 6, 10, 50, and 60, and it supports stripe sizes from 64k to 1M.



**NOTE** RAID levels 5, 50, 6, and 60 support requires purchase of the Feature on Demand upgrade.

See [Section 1.4.1, "Summary of RAID Levels"](#) for information about the supported RAID levels.

## 1.4 Replaceable Components

Field replacement units (FRUs) must be replaced by a trained service technician only.

For more information about the terms of the warranty and getting service and assistance, see the *Warranty Information* document that comes with the controller.

The following table describes the field replacement units.

**Table 1 Field Replaceable Units for the ServeRAID M5225-2GB Series Controller, Modules and Remote-mount Cables**

| Description                                                              | FRU Part Number<br>(trained service technician only) |
|--------------------------------------------------------------------------|------------------------------------------------------|
| ServeRAID M5225-2GB SAS/SATA Controller                                  | 00AE939                                              |
| ServeRAID M5100/M5200 Series Flash Power Module                          | 00JY023                                              |
| ServeRAID M5200 Series Remote-mount cable for Flash Power Module (925mm) | 46C9789                                              |
| ServeRAID M5200 Series Remote-mount cable for Flash Power Module (425mm) | 46C9790                                              |

## 1.4.1 Summary of RAID Levels

RAID levels describe a system for ensuring the availability and redundancy of data stored on large disk subsystems. [Table 2](#) describes the RAID levels.

Refer to the *ServeRAID-M Software User's Guide* for more information about RAID levels.

**Table 2 Summary of RAID Levels**

| Raid Level | Description                                                                                                                                                                                              | Comments                                                                                                                                                                                                                                                                                                                                                 |
|------------|----------------------------------------------------------------------------------------------------------------------------------------------------------------------------------------------------------|----------------------------------------------------------------------------------------------------------------------------------------------------------------------------------------------------------------------------------------------------------------------------------------------------------------------------------------------------------|
| 0          | RAID 0 uses striping to provide high data throughput                                                                                                                                                     | RAID 0 is well suited for large files in an environment that does not require fault tolerance.                                                                                                                                                                                                                                                           |
| 1          | RAID 1 uses mirroring so that data written to one drive is simultaneously written to another drive.                                                                                                      | RAID 1 is good for small databases or other applications that require small capacity but complete data redundancy.                                                                                                                                                                                                                                       |
| 5          | RAID 5 uses disk striping and parity data across all drives (distributed parity) to provide high data throughput, especially for small random access.                                                    | RAID 5 is best suited for networks that perform a lot of small input/output (I/O) transactions simultaneously.                                                                                                                                                                                                                                           |
| 6          | RAID 6 uses distributed parity, with two independent parity blocks per stripe, and disk striping.                                                                                                        | A RAID 6 virtual drive can survive the loss of two drives without losing data. A RAID 6 drive group, which requires a minimum of three drives, is similar to a RAID 5 drive group. Blocks of data and parity information are written across all drives. The parity information is used to recover the data if one or two drives fail in the drive group. |
| 10         | RAID 10, a combination of RAID 0 and RAID 1, consists of striped data across mirrored spans. A RAID 10 drive group is a spanned drive group that creates a striped set from a series of mirrored drives. | RAID 10 allows a maximum of eight spans. You must use an even number of drives, and the total number of drives must be divisible by 4 in each RAID 10 drive group in the span. The RAID 1 virtual drives must have the same stripe size. RAID 10 provides high data throughput and complete data redundancy but uses more spans.                         |
| 50         | RAID 50, a combination of RAID 0 and RAID 5, uses distributed parity and disk striping. A RAID 50 drive group is a spanned drive group in which data is striped across multiple RAID 5 drive groups.     | RAID 50 works best with data that requires high reliability, high request rates, high data transfers, and medium-to-large capacity.                                                                                                                                                                                                                      |
| 60         | RAID 60, a combination of RAID 0 and RAID 6, uses distributed parity, with two independent parity blocks per stripe in each RAID set, and disk striping.                                                 | A RAID 60 virtual drive can survive the loss of two drives in each of the RAID 6 sets without losing data. It works best with data that requires high reliability, high request rates, high data transfers, and medium-to-large capacity.                                                                                                                |



**NOTE** MegaRAID does not allow virtual drives of different RAID levels, such as RAID 0 and RAID 5, in the same drive group. For example, if an existing RAID 5 virtual drive is created out of partial space in a drive group, the next virtual drive in the drive group has to be RAID 5 only.

## 1.5 Configuration Scenarios

There are two main scenarios in which you can use this ServeRAID controller:

- Low-end, external SATA configuration: In this configuration, use the ServeRAID controller as a high-end SATA compatible controller that connects to several SATA disks. This type of configuration is mostly for low-end or entry level servers. Enclosure management is provided through out-of-band I2C bus. Side bands of both types of external SAS connectors support the SFF-8449 (SGPIO) interface.
- Midrange, external SAS configuration: This configuration is like the external SATA configuration, but with high-end disks. This type of configuration is more suitable for low-range to midrange servers.

The following figure shows a direct-connect configuration. The Inter-IC (I2C) interface communicates with peripherals. The external memory bus provides a 32-bit memory bus, parity checking, and chip select signals for pipelined synchronous burst static random access memory (PSBRAM), nonvolatile static random access memory (NVSRAM), and Flash ROM.

**Figure 1 Example of a SAS Direct Connect Application**

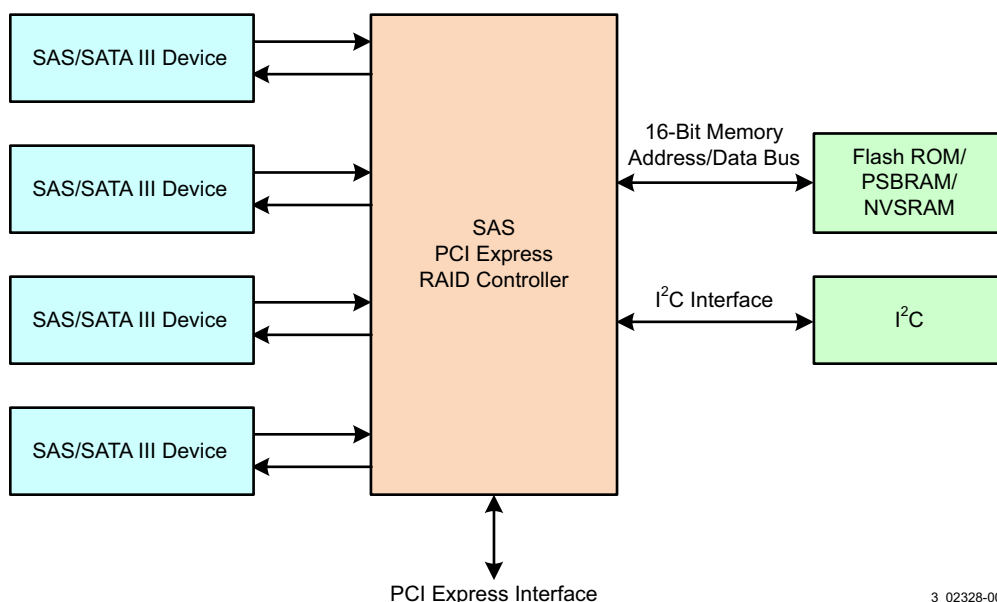

3\_02328-00

The following figure shows an example of a ServeRAID controller configured with an expander that is connected to SAS disks, SATA disks, or both.

**Figure 2 Example of a ServeRAID Controller Configured with an Expander**

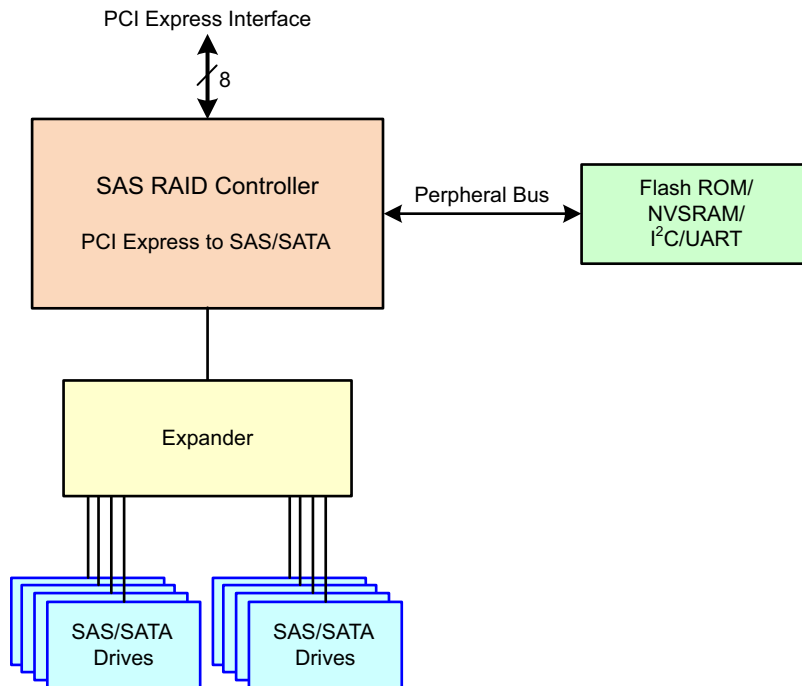

3\_02329-00

### 1.5.1 Number of Physical Disks Supported

Your configuration planning for your ServeRAID controller depends in part on the number of physical disks that you want to use in a RAID drive group. The number of drives in a drive group determines the RAID levels that can be supported by this controller. Only one RAID level can be assigned to each virtual drive. The following table shows the minimum number and the maximum number of drives required for each RAID level.

**Table 3 Physical Devices Required for each RAID Level**

| Raid Level | Minimum # of Physical Devices | Maximum # of Physical Devices |
|------------|-------------------------------|-------------------------------|
| 0          | 1                             | 32                            |
| 1          | 2                             | 32                            |
| 5          | 3                             | 32                            |
| 6          | 4                             | 32                            |
| 10         | 4                             | 32                            |
| 50         | 6                             | 32                            |
| 60         | 6                             | 32                            |

## 1.6 SAS Protocols

The controller supports the SAS protocol as described in the Serial Attached SCSI Standard, version 3.0, and the SATA III protocol defined by the *Serial ATA Revision 3.0 Specification*.



**NOTE** You cannot mix SAS drives and SATA drives within the same virtual drive.

Each port on the controller supports SAS devices and/or SATA devices using the following:

- SAS Serial SCSI Protocol (SSP), which enables communication with other SAS devices
- SATA, which enables communication with other SATA devices
- Serial Management Protocol (SMP), which communicates topology management information directly with an attached SAS expander device
- Serial Tunneling Protocol (STP), which enables communication with a SATA device through an attached expander

## 1.7 Benefits of the SAS Interface

SAS is a serial, point-to-point, enterprise-level device interface that leverages the proven SCSI protocol set. SAS combines the advantages of SATA, SCSI, and Fibre Channel, and is the future mainstay of the enterprise and high-end workstation storage markets. SAS offers a higher bandwidth per pin than parallel SCSI, and it improves signal and data integrity.

The SAS interface uses the proven SCSI command set to ensure reliable data transfers, while providing the connectivity and flexibility of point-to-point serial data transfers. The serial transmission of SCSI commands eliminates clock-skew challenges. The SAS interface provides improved performance, simplified cabling, smaller connectors, lower pin count, and lower power requirements when compared to parallel SCSI.

The ServeRAID M5225-2GB SAS/SATA controller leverages a common electrical and physical connection interface that is compatible with Serial ATA technology. The point-to-point SATA III architecture eliminates inherent difficulties created by the legacy ATA master-slave architecture, while maintaining compatibility with existing ATA firmware.

### 1.7.1 PCI Express Architecture

PCI Express is a local bus system designed to increase data transfers without slowing down the central processing unit (CPU). You can install your ServeRAID M5225-2GB SAS/SATA controller in PCI Express computer systems with a standard bracket type. With this controller in your system, you can connect SCSI devices and SATA devices over the bus.

PCI Express goes beyond the PCI specification in that it is intended as a unifying I/O architecture for various systems: desktops, workstations, mobile, server, communications, and embedded devices.

### 1.7.2 Operating System Support

To check for the latest list of supported operating systems and to download the device drivers for those operating systems, see <http://www.ibm.com/systems/support/>.

The ServeRAID M5225-2GB controller uses Fusion-MPT architecture for all major operating systems, thinner device drivers, and better performance.



---

## 1.8 Benefits of the ServeRAID M5225-2GB SAS/SATA Controller

This section provides a summary of the features and the benefits of the ServeRAID M5225-2GB SAS/SATA controller. It contains information on SAS features, SATA features, PCI performance, integration, usability, and flexibility.

The controller offers the following features:

- PCI Express x8 lane width
- PCI Express performance up to 8 GT/s (1 GB/s) per lane
- Two external connectors
- Support for RAID levels 0, 1, 5, 6, 10, 50, and 60
- Advanced drive group configuration and management utilities
- Online RAID level migration
- Drive migration
- Drive roaming
- Media scan
- No reboot necessary after expansion
- More than 200 Qtags per drive group
- User-specified rebuild rate
- 32-Kbyte nonvolatile random access memory (NVRAM) for storing RAID system configuration information; the MegaRAID SAS firmware is stored in flash ROM for easy upgrade.



**NOTE** RAID levels 5, 50, 6, and 60 support requires purchase of the Feature on Demand upgrade.

---

### 1.8.1 SAS Features

The following list describes the SAS features of the ServeRAID M5225-2GB controller:

- Provides eight fully independent PHYs
- Supports 12.0 Gb/s SAS data transfers per PHY
- Supports SSP to enable communication with other SAS devices
- Supports SMP to communicate topology management information
- Provides a serial, point-to-point, enterprise-level storage interface
- Simplifies cabling between devices
- Supports wide ports consisting of 2, 3, or 4 PHYs within a single quad port
- Supports narrow ports consisting of a single PHY
- Transfers data using SCSI information units

## 1.8.2 SAS Drive Group Limitations

This section describes the drive group limitations of the controller. These include limitations such as the number of physical disks supported, the maximum number of disks per controller, and the maximum number of virtual drives allowed per controller.

Table 4 lists the drive group limitations for the ServeRAID M5225-2GB controller.

**Table 4 ServeRAID M5225-2GB SAS/SATA Controller Drive Group Limitations**

| Specification                            | Number Supported |
|------------------------------------------|------------------|
| Maximum virtual drives per controller    | 64               |
| Maximum drive groups per controller      | 128              |
| Maximum virtual drives per drive group   | 16               |
| Maximum physical devices per drive group | 32               |
| Maximum physical devices per controller  | 240              |
| Maximum hot spares per controller        | 240              |
| Maximum spans per virtual drive          | 8                |
| Maximum Ports                            | 2                |



**NOTE** The maximum number of hot spares per drive group is equal to the maximum number of drives per drive group.

The controller supports 64-bit logical block addressing (LBA), which makes it possible to connect a large number of drives to the RAID controller, directly and through expanders. However, the actual number of drives that you can attach depends on the limits listed in Table 3 rather than by the actual RAID volume capacity.

The maximum number of drives supported in Table 4 depends on how many physical devices you have connected to the controller. In addition, though you can have up to 16 virtual drives per drive group, and up to 128 drive groups per controller, there is a limit of 64 virtual drives per controller.

## 1.8.3 SATA III Features

The following list describes the SATA III features of the ServeRAID M5225-2GB controller:

- Supports SATA III data transfers of 6.0 Gb/s
- Supports STP data transfers of 3.0 Gb/s
- Provides a serial, point-to-point storage interface
- Simplifies cabling between devices
- Eliminates the master-slave construction used in parallel ATA
- Allows addressing of multiple SATA III targets through an expander
- Allows multiple initiators to address a single target (in a fail-over configuration) through an expander
- Displays activity and fault indicators for each PHY
- Supports Port Selector (for dual-port drives)
- Each port on the controller supports SAS devices, SATA devices, or both using SSP, SMP, STP, and SATA. SSP enables communication with other SAS devices.
- Enables the controller to communicate with other SATA devices.
- Supports staggered spin-up
- Supports hot plug

---

## 1.8.4 PCI Express Performance

The following list describes the PCI Express performance features of the ServeRAID M5225-2GB controller:

- Provides a PCI Express 3.0 interface that:
  - Supports a dedicated PCI Express bus
  - Supports x8 lane configuration
  - Supports transfer rates of up to 8 GT/s (1 GB/s) per lane
  - Complies with the PCI Express Specification, Revision 3.0
- Provides unequalled performance through the Fusion-MPT architecture
- Provides high throughput and low CPU utilization to offload the host processor

## 1.8.5 Usability Features

The following list describes the usability features of the ServeRAID M5225-2GB controller:

- Simplifies cabling with point-to-point, serial architecture
- Supports smaller, thinner cables that do not restrict airflow
- Provides drive spin-up sequencing control
- Provides up to two LED signals for each PHY to indicate link activity and faults
- Provides an I2C interface for enclosure management
- Supports the external SAS Sideband signal SFF-8449 (SGPIO) standards.

## 1.8.6 Flexibility Features

These features increase the flexibility of the ServeRAID M5225-2GB controller:

- Supports a Flash ROM interface, a nonvolatile static RAM (NVS RAM) interface, and a pipelined synchronous burst SRAM (PSBRAM) interface
- Offers a flexible programming interface to tune I/O performance
- Allows mixed connections to SAS targets or SATA III targets
- Leverages compatible connectors for SAS connections and SATA III connections
- Allows grouping of up to four PHYs in a single quad port to form a wide port
- Allows programming of the World Wide Name

## 1.8.7 CacheCade

CacheCade is an advanced software option that is designed to accelerate the performance of hard disk drive (HDD) drive groups with only an incremental investment in SSD technology. The MegaRAID CacheCade software utilizes SSDs as a dedicated pool of high-performance cache in front of HDDs to maximize I/O performance for transaction intensive applications.



**NOTE** The CacheCade software option requires purchase of the Feature on Demand upgrade.

---

The key benefits of this software option include:

- Accelerated performance of existing HDD drive groups with a small up-front investment
- Read and Write caching of hot spot data for significant reduction in I/O latency
- Optimized for real-world workloads of transaction-intensive applications

- Simple, intuitive management tools to assign and manage CacheCade SSD pool

These features help reduce latency bottlenecks for server-based HDD volumes. Applications are often constrained by the performance limitations of their existing HDDs. With this type of storage infrastructure already in place, a switch to a new drive group based purely on SSDs is cost prohibitive. Although SSDs are capable of many more transactions per second than HDDs, SSDs have a very high cost per gigabyte and are not suited for heavy, large file workloads. You can accelerate the performance of existing HDD drive groups without making substantial investments in new hardware by deploying LSI MegaRAID CacheCade software, which leverages SSDs in front of HDD volumes to create high-capacity, high-performance controller cache pools.

### 1.8.8 Protection Information (T10-DIF)

The T10 Technical Committee of the INCITS standardized the basic requirements to implement a data protection model for end-to-end data protection. This model protects your data within a storage system from various sources of corruption that historically have gone undetected. Examples of corruption sources include hardware datapath errors (such as FIFO overruns and underruns), firmware errors (such as arithmetic overflow or incorrect pointer usage), and external agents overwriting the data in memory.

A fundamental component of the T10 data protection model is the addition of 8 bytes of extra protection information transferred with each block of user data in the storage system, as shown in the following figure. Although not specifically named in the T10 standards, this collection of 8 bytes is commonly referred to as the DIF. The DIF contains three distinct values: a 2-byte logical block guard, a 2-byte logical block application tag, and a 4-byte logical block reference tag. The T10 specification defines four types of usage models of data protection: Type 0, Type 1, Type 2, and Type 3 (refer to the most current revision of INCITS T10/1799-D for further information)

**Figure 3 T10 Data Integrity Field for MegaRAID Protection Information**

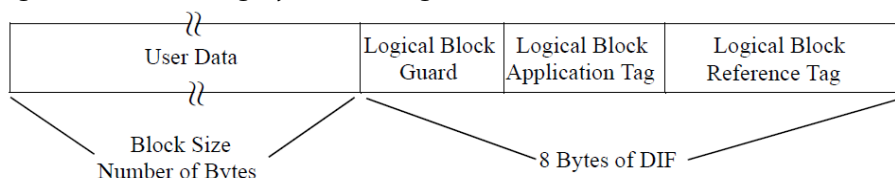

### 1.8.9 Drive Roaming

Drive roaming occurs when the physical disks are changed to different ports on the same controller. When the drives are placed on different channels, the controller detects the RAID configuration from the configuration data on the drives.



**NOTE** In a clustering environment, drive roaming is supported within the same channel only.

Configuration data is saved in both the NVRAM on the RAID controller and on the drives attached to the controller. This action maintains the integrity of the data on each drive, even if the drives have changed their target ID.



**NOTE** If you move a drive that is being rebuilt, the rebuild operation restarts; it does not resume from where the rebuild operation stopped.

Follow these steps to use drive roaming:

1. Turn off the power to the server and all physical disks, enclosures, and system components. Disconnect the power cords from the system.
2. Remove the server cover by following the instructions in the host system technical documentation.

3. Move the drives to different positions on the storage enclosure to change the targets.
4. Determine the SAS target requirements.
5. Perform a safety check.
6. Make sure that the drives are inserted correctly.
7. Reinstall the server cover.
8. Reconnect the power cords to the system.
9. Turn on the power to the system.
10. The controller then detects the RAID configuration from the configuration data on the drives.

### 1.8.10 Drive Migration

Drive migration is the transfer of a set of drives in an existing configuration from one controller to another. The drives must remain on the same channel and they must be reinstalled in the same order as in the original configuration. The controller to which you migrate the drives cannot have an existing configuration.



**NOTE** Only whole virtual drives can be migrated automatically; partial virtual drives can be migrated manually.



**NOTE** Drive roaming and drive migration cannot be supported at the same time.

Follow these steps to migrate drives:

1. Make sure that you clear the configuration on the system to which you migrate the drives, to prevent a configuration data mismatch between the drives and the NVRAM.
2. Turn off the power to the server and all physical disks, enclosures, and system components. Disconnect the power cords from the systems.
3. Remove the physical disks from the first system, and insert them into drive bays on the second system.
4. Perform a safety check.
5. Make sure that all of the cables are attached correctly.
6. Make sure that the controller is installed correctly.
7. Reconnect the power cords to the system.
8. Turn on the power to the system.
9. The controller detects the configuration from the configuration data on the drives.

### 1.8.11 Automatic Rebuilds on New Drives

Automatic rebuilds occur when the drive slot status changes. For example, an automatic rebuild occurs when you insert a new drive or when you remove a drive and a hot spare replaces the removed drive.

## 1.9 Hardware Specifications

You can install your ServeRAID M5225-2GB controller in a computer with a mainboard that has a PCI Express slot. [Table 5](#) describes the hardware configuration features of the controller.

**Table 5 ServeRAID M5225-2GB SAS/SATA Controller**

| Feature                                                                                                                                                                                                                                                                                                        | ServeRAID M5225-2GB SAS/SATA Controller                              |
|----------------------------------------------------------------------------------------------------------------------------------------------------------------------------------------------------------------------------------------------------------------------------------------------------------------|----------------------------------------------------------------------|
| RAID Levels                                                                                                                                                                                                                                                                                                    | i0, 1, 5*, 6*, 10, 50*, and 60*                                      |
| Devices Supported per Port                                                                                                                                                                                                                                                                                     | Up to 8 SAS devices or 8 SATA devices (such as drives and expanders) |
| Ports                                                                                                                                                                                                                                                                                                          | Eight external                                                       |
| Data Transfer Rate                                                                                                                                                                                                                                                                                             | Up to 12Gb/s per phy                                                 |
| Bus                                                                                                                                                                                                                                                                                                            | PCI Express 3.0                                                      |
| Cache Function                                                                                                                                                                                                                                                                                                 | Yes. See the note at the bottom of this table\                       |
| Multiple Virtual Drives per Controller                                                                                                                                                                                                                                                                         | Yes. Up to 64 virtual drives per controller                          |
| Multiple Drive Groups per Controller                                                                                                                                                                                                                                                                           | Yes. Up to 128 drive groups per controller                           |
| Online Capacity Expansion                                                                                                                                                                                                                                                                                      | Yes                                                                  |
| Dedicated and Global Hot Spares                                                                                                                                                                                                                                                                                | Yes                                                                  |
| Hot Swap Devices Supported                                                                                                                                                                                                                                                                                     | Yes                                                                  |
| Non-Disk Devices Supported                                                                                                                                                                                                                                                                                     | Yes                                                                  |
| Mixed Capacity Physical Disks Supported                                                                                                                                                                                                                                                                        | Yes                                                                  |
| Number of external Connectors                                                                                                                                                                                                                                                                                  | Two SFF-8644 HD-4e external connectors                               |
| Hardware Exclusive OR (XOR) Assistance                                                                                                                                                                                                                                                                         | Yes                                                                  |
| Direct I/O                                                                                                                                                                                                                                                                                                     | Yes                                                                  |
| Architecture                                                                                                                                                                                                                                                                                                   | Fusion-MPT                                                           |
| * RAID levels 5, 50, 6, and 60 support requires purchase of the Feature on Demand upgrade.                                                                                                                                                                                                                     |                                                                      |
| <b>NOTE</b> In MR mode, the ServeRAID M5225-2GB SAS\SATA controller supports cache policy, which includes write-back, write-through, adaptive read ahead, non-read ahead, read ahead, cache I/O, and direct I/O settings. See <a href="#">Section 1.3, "MegaRAID Mode"</a> for more information about MR mode. |                                                                      |

## 1.10 Technical Support

For information about the technical support available for this product, see [Appendix A: Getting Help and Technical Assistance](#).

---

# Chapter 2: ServeRAID M5225-2GB Controller Hardware Installation

## 2.1 Requirements

The following items are required for installation:

- A ServeRAID M5225-2GB SAS/SATA controller
- A host system with an available PCI Express expansion slot
- The ServeRAID M Documentation CD containing the documentation
- External SAS cables
- Flash Power Module and cable
- Enclosure containing SAS physical disks or SATA physical disks (disk drives or Solid State Devices, SSDs)



**NOTE** For optimal performance, use an un-interruptible power supply.

---

## 2.2 Installing the Controller

This section provides detailed instructions for installing a ServeRAID M5225-2GB controller.

### 1. Unpack the Controller

Unpack and remove the controller. Inspect it for damage. If it appears damaged, or if any of the following items are missing, contact your place of purchase. The controller is shipped with the following items:

- A CD containing an electronic version of this User's Guide and other related documentation
- Warranty information

### 2. Turn off the Power to the System

Review all safety information provided with the server; then, turn off the power to the server, unplug the power cords from the power supplies, disconnect the server from the network, and remove the server cover. See the documentation provided with the server for instructions. Before you install the controller, make sure that the server is disconnected from the power and from any networks.

### 3. Review the Controller Connectors

Refer to [Chapter 3: ServeRAID M5225-2GB SAS/SATA Controller Characteristics](#) for a diagram of the ServeRAID M5225-2GB controller with its connectors.

### 4. Review the Controller Limitations

Review [Section 1.2, "Controller Guidelines,"](#) before you install the controller in the system.

### 5. Install the Controller

Select a PCI Express slot and align the controller's PCI Express bus connector to the slot. Press down gently but firmly to ensure that the controller is correctly seated in the slot. Secure the bracket to the server chassis.

The following figure shows the installation of the ServeRAID M5225-2GB controller in a PCI Express slot.



**NOTE** Some PCI Express slots support PCI Express graphics cards only. A RAID controller installed in one of these slots will not function.

---



**ATTENTION** To avoid damage to the server, always remove the controller from the PCI Express slot before you relocate or ship the server.

**Figure 1** ServeRAID M5225-2GB Controller Installation in a PCI Express Slot

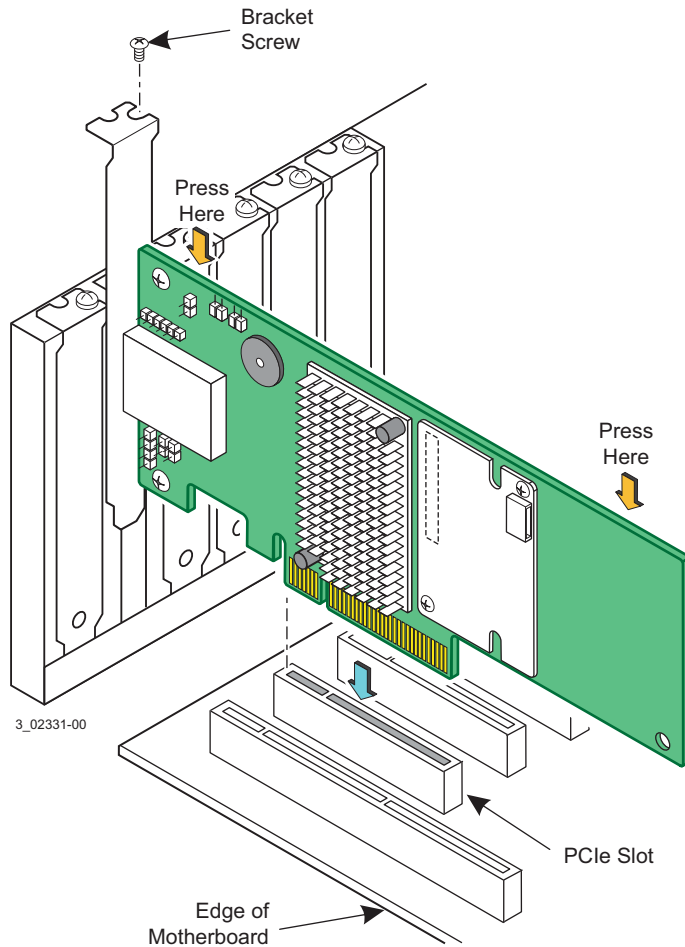

**6. Connect SAS cables between the controller and the Storage Enclosure (if applicable)**

Connect serial cables between the controller and a storage enclosure or any other SATA devices or SAS devices. The preceding figure shows the locations of the controller connectors. The controller uses two SFF-8644 HD-4e external connectors to connect to external devices. You may use other cables appropriate for your usage scenario as long as they conform to the controller specifications and limitations.

See [Section 2.4, "Connecting a ServeRAID M5225-2GB SAS/SATA Controller to a Storage Enclosure,"](#) for details about connecting the controller to the enclosure.

**7. Replace the cover and any power cords, and power up the system**

Reinstall the server cover and reconnect the AC power cords; then, turn on the power to the server.

Make sure that the power is turned on to the SAS devices and the SATA III devices before or at the same time as the host server. If the power is turned on to the server before it is turned on to the devices, the server might not recognize the devices.

For the Unified Extensible Firmware Interface (UEFI), no BIOS message displays. Press F1 to enter System Setup. Refer to your system user's guide for specific configuration information.



---

Under other interfaces or operating systems, a BIOS message appears during boot. The firmware takes several seconds to initialize. The configuration utility prompt times out after several seconds. The second portion of the BIOS message displays the controller number, firmware version, and cache SDRAM size. The numbering of the controller follows the PCI slot scanning order used by the host system board.

### 8. Run the Configuration Utility

Run the WebBIOS Configuration Utility or the HII Configuration Utility to configure the physical drive groups and the logical drives.

To run the WebBIOS utility, when the message `Press <Ctrl><H> for WebBIOS` appears on the screen, press CTRL+H immediately.

To run the HII utility, boot the computer and press the appropriate key to start the setup utility during bootup.



**NOTE** The startup key might be F2 or F1 or some other key, depending on the system implementation. Refer to the on-screen text or the vendor-specific documentation for more information.

---

### 9. Install the Operating System Device Driver

The controller can operate under various operating systems. To operate under these operating systems, you must install the software device drivers. You can find and download the latest device drivers at <http://www.ibm.com/support/>. For updates, click **Support & downloads**.

Device driver updates are made available periodically. To ensure that you have the current version of the device driver, download the latest device driver at <http://www.ibm.com/support/>. See the readme file that accompanies the device driver for any updated information.

For details on installing the device driver, refer to the *ServeRAID-M Device Driver Installation User's Guide* on the ServeRAID matrix website at this link <http://www.ibm.com/support/>. Be sure to use the latest Service Packs provided by the operating system manufacturer and to review the readme file that accompanies the device driver.

## 2.3 Installing and Connecting the Flash Power Module

After you install the controller, follow these steps to install the Flash Power Module and then connect the Memory Module on your ServeRAID M5225-2GB controller by cable to the Flash Power Module.

1. Make sure that the power to the chassis is still turned off, the power cords are unplugged, and the chassis is grounded and has no AC power.
2. Mount the Flash Power Module to the chassis of your system based on the location and the type of mounting option.



**NOTE** Because server and workstation chassis vary, no standard mounting option exists that is compatible with the various system configurations. You can customize the location of the Flash Power Module to provide the most flexibility within your environment.

- 
3. Insert the 9-pin connector on the cable into the 9-pin J1 connector on the Memory Module, as shown in the following figure.

The cable has a 9-pin connector on one end and a 6-pin connector on the other.

4. Insert the other 6-pin connector into the 6-pin connector on the cable from the remote Flash Power Module.  
Align the cable connectors to make sure that they are connected correctly.

**Figure 2 Connecting the Memory Module by Cable to the Remote Flash Power Module**

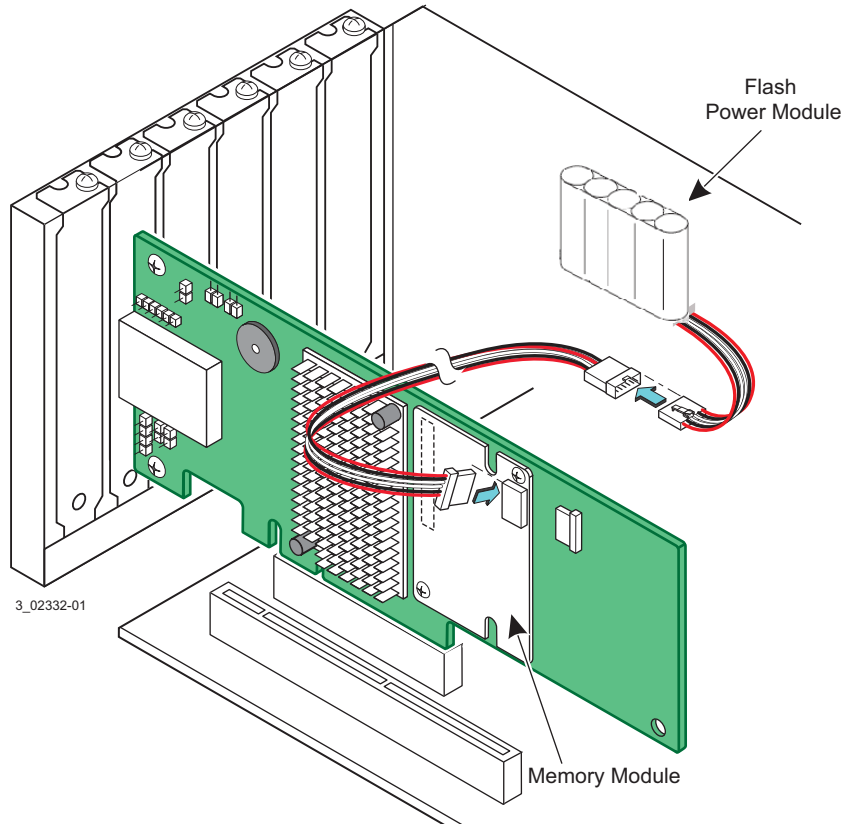

5. Reinstall the computer cover, and reattach the power cords.
6. Turn on the power to the computer.

## 2.4 Connecting a ServeRAID M5225-2GB SAS/SATA Controller to a Storage Enclosure

This section describes how to connect the ServeRAID M5225-2GB SAS/SATA controller by cable to a storage enclosure. The enclosure can contain SAS drives and SATA drives.

A cable with an SFF-8644 HD-4e external connector at one end and at the other end a connector compatible with the storage enclosure is used to connect the controller to the storage enclosure containing SAS drives and/or SATA drives.

Follow these steps to connect the external connector on the cable to the controller and the storage enclosure:

1. Plug the SFF-8644 HD-4e external connector on one end of the cable into the x4 SAS port 0-3 connector on the controller, as shown in the following figure.
2. Plug the connector on the other end of the cable into the port connector on the storage enclosure.  
You can use a second cable to connect the other SFF-8644 HD-4e external connector on the controller to the port connector on another storage enclosure.

**Figure 3 Connecting the Controller External Connector to a Storage Enclosure**

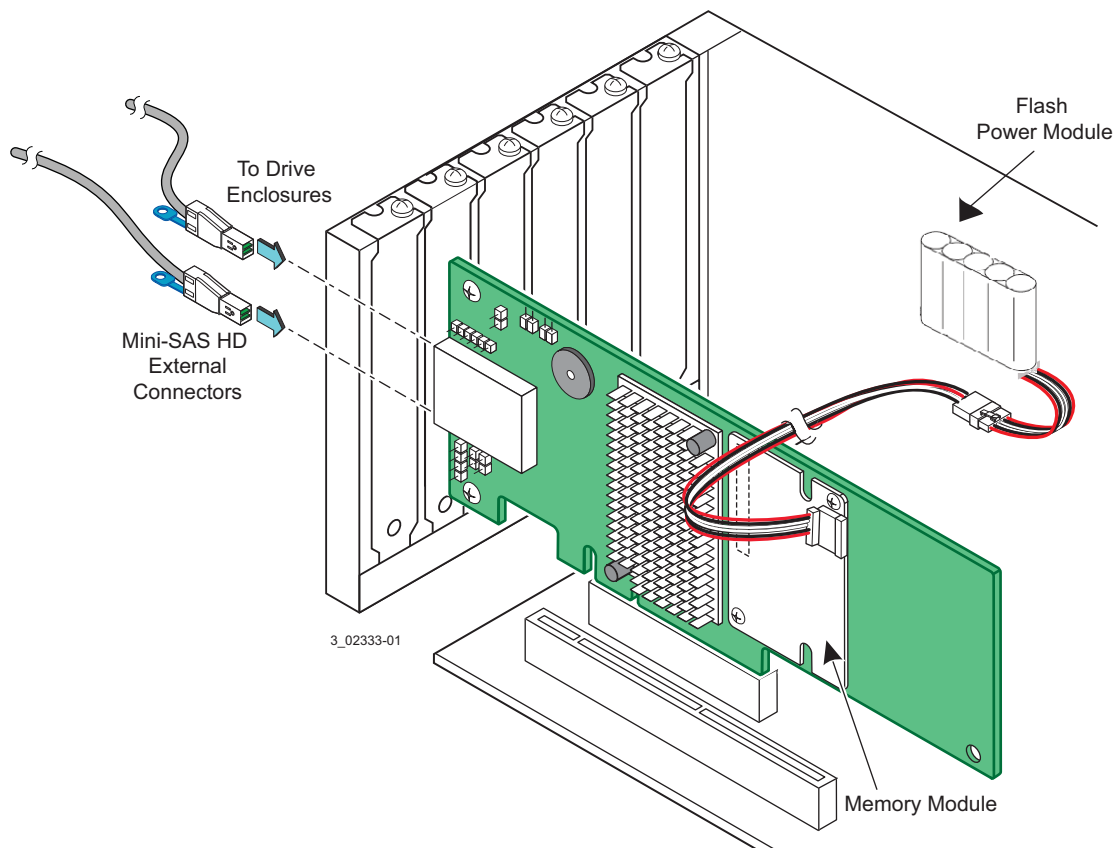

---

## 2.5 After Installing the Controller

After you install the controller, you must configure it and install the operating system device driver. The *ServeRAID-M Software User's Guide* instructs you on the configuration options and how to set them on your controller. The *ServeRAID-M Device Driver Installation User's Guide* provides detailed installation instructions for operating system device drivers.

## 2.6 Replacing a Full-Profile Bracket with a Low-Profile Bracket

All work must be performed at an ESD-safe workstation that meets the requirements of EIA-625 - *Requirements For Handling Electrostatic Discharge Sensitive Devices*. You must perform all actions according to the latest revision of the IPC-A-610 ESD-recommended practices.

1. At an ESD-safe workstation, remove the board from its ESD protective bag.
2. Use an ESD-safe #1 Phillips screwdriver to carefully remove the two Phillips screws that connect the full profile bracket to the board. Unscrew the two screws located at the top and bottom edges of the board.



**NOTE** Damaging the screw can void the warranty. To prevent damage to the screw, make sure the screwdriver is centered in the top of the screw.

3. Remove the full profile bracket from the RAID controller. Be careful not to damage the board.
4. Place the controller on top of the low profile bracket. Make sure to position the bracket so that the screw holes in the tabs are aligned with the openings in the board.
5. Use an ESD-safe #1 Phillips torque screwdriver set to a maximum torque of 4.8 +/- 0.5 inch pounds. Replace the two Phillips head screws removed in step 2.



**NOTE** Exceeding this torque specification can damage the board, connectors or screws, and can void the warranty on the board.

6. Place the board back in its ESD-protective bag, and seal the bag appropriately.



**NOTE** Warranty does not recover the return of parts that are damaged by changing the bracket. Warranty does not cover ESD damage to the board. Boards returned without a bracket mounted on the board will be returned without RMA processing.

---

# Chapter 3: ServeRAID M5225-2GB SAS/SATA Controller Characteristics

## 3.1 Board Layout and Connector Information

This section provides the board layout and connector information for the controller. The following section provides detailed technical information about the controller.

The following figure displays the connectors on the controller, which are described on [Table 1](#). Pin 1 on each connector is highlighted in red.

**Figure 1 Card Layout for the ServeRAID M5225-2GB SAS/SATA Controller**

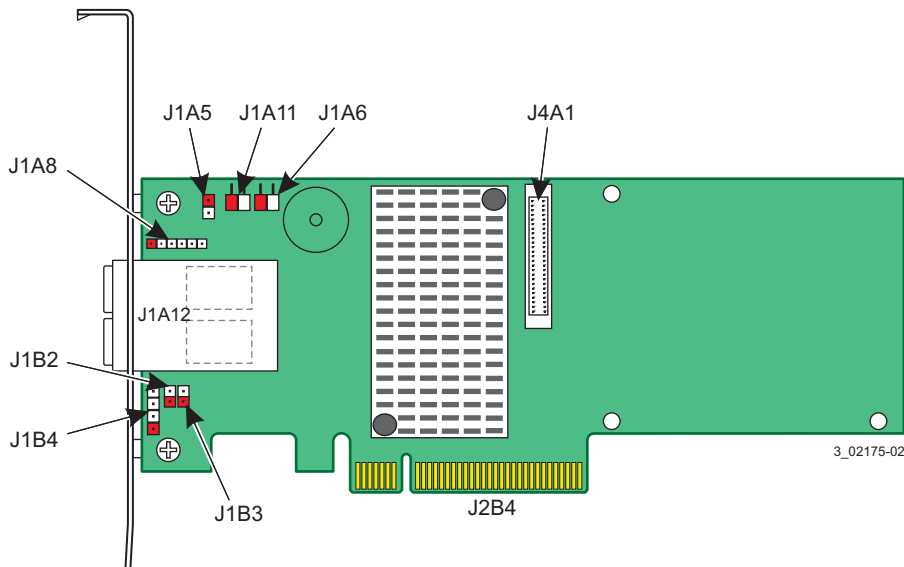

**NOTE** The Memory Module comes pre-installed on the controller, but it is not shown in this figure so that you can see the J4A1 connector.

**Table 1 Controller Connectors**

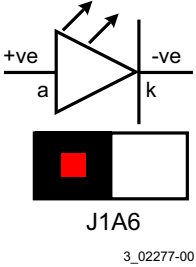
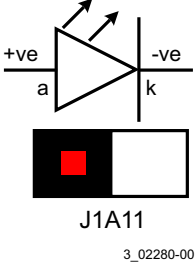
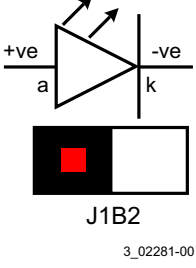
| Header/<br>Connector | Type                                                                                                                                   | Description                                                                                                                                                          |
|----------------------|----------------------------------------------------------------------------------------------------------------------------------------|----------------------------------------------------------------------------------------------------------------------------------------------------------------------|
| J1A5                 | Default Serial boot ROM (SBR) header                                                                                                   | 2-pin connector<br>Reserved for LSI use.                                                                                                                             |
| J1A6                 | Global drive fault LED header<br>                     | 2-pin connector<br>Connects to an LED that indicates activity on the drives connected to the controller.                                                             |
| J1A8                 | CPLD header                                                                                                                            | 5-pin connector<br>Reserved for LSI use.                                                                                                                             |
| J1A11                | Global hard disk drive (HDD) activity LED header<br> | 2-pin connector<br>Connects to an LED that indicates activity on the drives connected to the controller.                                                             |
| J1A12                | SAS Port 0 through Port 7 external connector                                                                                           | Two SFF-8644 mini-SAS HD-4e external connectors<br>Connects the controller by cable to an enclosure containing SAS drives or SATA drives.                            |
| J1B2                 | Cache write pending header<br>                      | 2-pin connector.<br>Connector for an LED mounted on the system enclosure. The LED indicates that the data in the cache has yet to be written to the storage devices. |
| J1B3                 | LSI Test header                                                                                                                        | 2-pin connector<br>Reserved for LSI use.                                                                                                                             |

**Table 1 Controller Connectors**

| Header/<br>Connector | Type                                                                         | Description                                                                                                                                                                                                                                                                |
|----------------------|------------------------------------------------------------------------------|----------------------------------------------------------------------------------------------------------------------------------------------------------------------------------------------------------------------------------------------------------------------------|
| J1B4                 | On-board Serial Universal Asynchronous Receiver/Transmitter (UART) connector | 4-pin connector<br>Reserved for LSI use.                                                                                                                                                                                                                                   |
| J2B4                 | Standard edge card connector                                                 | The interface between the RAID controller and the host system. Along with the PCIe interface, this connector provides power to the board and an I <sup>2</sup> C interface connected to the I <sup>2</sup> C bus for the Intelligent Platform Management Interface (IPMI). |
| J4A1                 | Memory Module (ONFI) interface                                               | 80-pin connector<br>Connects the RAID controller to a flash module.                                                                                                                                                                                                        |

## 3.2 Characteristics of the ServeRAID M5225-2GB SAS/SATA Controller

Table 2 shows the general characteristics of the ServeRAID M5225-2GB SAS/SATA controller

**Table 2 SAS/SATA Controller Characteristics**

| Flash ROM             | Serial EEPROM | SAS Data Transfers     |
|-----------------------|---------------|------------------------|
| Up to 32MB flash size | 32 Kb         | Up to 12 Gb/s per port |

The controller ensures data integrity by intelligently validating the compatibility of the SAS domain. The controller Fusion-MPT architecture allows for thinner device drivers and better performance.

### 3.2.1 Controller Specifications

Table 3 lists the specifications for the ServeRAID M5225-2GB SAS/SATA controller.

**Table 3 ServeRAID M5225-2GB SAS/SATA Controller Specifications**

| Specification                                                              | ServeRAID M5225-2GB SAS/SATA Controller                                                                       |
|----------------------------------------------------------------------------|---------------------------------------------------------------------------------------------------------------|
| Processor<br>(PCI Express Host Controller to PCI Secondary I/O Controller) | LSISAS3108 PCI-Express RoC device processor                                                                   |
| Operating Voltage                                                          | +3.3 V, +12 V                                                                                                 |
| Card Size                                                                  | Low-profile PCI Express controller card size (68.90 mm × 167.65 mm)                                           |
| Interface to Host                                                          | PCI Express Rev 3.0                                                                                           |
| Type of Drives Supported                                                   | Serial Attached SCSI (SAS) and Serial ATA (SATA)                                                              |
| PCI Express Bus Data Transfer Rate                                         | Up to 8 GT/s (1 GB/s) per lane<br>x8 lane width<br>Up to 2 GB/s per direction for SAS x4 cards (4 GB/s total) |
| Serial Port                                                                | 3-pin RS232-compatible connector (for manufacturing use only)                                                 |
| SAS Controller(s)                                                          | One LSISAS3108 Single SAS controller                                                                          |
| SAS Bus Speed                                                              | 12 Gb/s                                                                                                       |

**Table 3 ServeRAID M5225-2GB SAS/SATA Controller Specifications**

| Specification                            | ServeRAID M5225-2GB SAS/SATA Controller     |
|------------------------------------------|---------------------------------------------|
| SAS Ports                                | Two SAS connectors with four SAS ports each |
| Size of Flash ROM for Firmware           | 8 Mbytes                                    |
| Nonvolatile Random Access Memory (NVRAM) | 32 Kbytes for storing RAID configuration    |

### 3.2.2 Drive Group Performance Features

Table 4 shows the drive group performance features for the ServeRAID M5225-2GB SAS/SATA controller.

**Table 4 Drive Group Performance Features**

| Specification                         | ServeRAID M5225-2GB SAS/SATA Controller |
|---------------------------------------|-----------------------------------------|
| PCI Express Host Data Transfer Rate   | 8 GT/s (1 GB/s) per lane                |
| Drive Data Transfer Rate              | 12.0 Gb/s per lane                      |
| Maximum Scatter/Gathers               | 26 elements                             |
| Maximum Size of I/O Requests          | 6.4 Mbytes in 64 Kbyte stripes          |
| Maximum Queue Tags per Drive          | As many as the drive can accept         |
| Stripe Sizes                          | 8, 16, 32, or 64 Kbyte                  |
| Maximum Number of Concurrent Commands | 255                                     |

### 3.2.3 Fault Tolerance

**Table 5 Fault Tolerance Features**

| Specification                  | ServeRAID M5225-2GB SAS/SATA Controller |
|--------------------------------|-----------------------------------------|
| Support for SMART              | Yes                                     |
| Drive Failure Detection        | Automatic                               |
| Drive Rebuild Using Hot Spares | Automatic                               |
| Parity Generation and Checking | Yes                                     |



### 3.2.4 Power Supply Requirements for the ServeRAID M5225-2GB SAS/SATA Controller

All power is supplied to the controller through the PCI Express 3.3V rails and the 12V rail. Onboard switching regulator circuitry operating from the 3.3V rails and the 12V rail provides the necessary voltages. The following states determine the typical current consumption of the controller:

1. State 1: While sitting idle at the DOS prompt
2. State 2: During a drive stress test
3. State 3: Power on the controller with a deeply depleted Flash Power Module attached

The supply voltages are  $12V \pm 8$  percent (from PCI edge connector only) and  $3.3V \pm 9$  percent (from PCI edge connector only). The following table lists the power supply for the controller for each of the three states at the different voltages.

**Table 6 Power Supply**

| PCI Edge Connector    | State 1 | State 2 | State 3 |
|-----------------------|---------|---------|---------|
| 3.3V Supply           | 800mA   | 880mA   | 800mA   |
| +12V Supply           | 1000mA  | 1220mA  | 1520mA  |
| 3.3V Auxiliary Supply | 20mA    | 20mA    | 10mA    |
| Total Power           | 14.95W  | 17.91W  | 21.266W |

### 3.2.5 Operating and Non-operating Conditions

The operating (thermal and atmospheric) conditions for the ServeRAID M5225-2GB SAS/SATA controller are:

- Relative humidity range is 20 percent to 80 percent noncondensing
- Airflow must be at least 200 linear feet per minute (LFPM) to avoid operating the Intel IOP333 processor above the maximum ambient temperature
- Temperature range: +10 °C to +55 °C

The parameters for the non-operating (such as storage and transit) environment for the controller are:

- Relative humidity range is 20 percent to 95 percent noncondensing
- Temperature range: -30 °C to +115 °C

### 3.2.6 Safety Characteristics

The ServeRAID M5225-2GB SAS/SATA controller meets or exceeds the requirements of UL flammability rating 94 V0. Each bare board is also marked with the supplier name or trademark, type, and UL flammability rating. The board is installed in a PCI Express bus slot, so all voltages are lower than the SELV 42.4 V limit.

---

## Appendix A: Getting Help and Technical Assistance

If you need help, service, or technical assistance or just want more information about Lenovo products, you will find a wide variety of sources available from Lenovo to assist you.

Use this information to obtain additional information about Lenovo and Lenovo products, and determine what to do if you experience a problem with your Lenovo system or optional device.

**Note:** This section includes references to IBM web sites and information about obtaining service. IBM is Lenovo's preferred service provider for the BladeCenter, System x, Flex System, and NeXtScale System products.

### A.1 Before You Call

Before you call, make sure that you have taken these steps to try to solve the problem yourself.

If you believe that you require warranty service for your Lenovo product, the service technicians will be able to assist you more efficiently if you prepare before you call.

- Check all cables to make sure that they are connected.
- Check the power switches to make sure that the system and any optional devices are turned on.
- Check for updated software, firmware, and operating-system device drivers for your Lenovo product. The Lenovo Warranty terms and conditions state that you, the owner of the Lenovo product, are responsible for maintaining and updating all software and firmware for the product (unless it is covered by an additional maintenance contract). Your service technician will request that you upgrade your software and firmware if the problem has a documented solution within a software upgrade.
- If you have installed new hardware or software in your environment, check <http://www.ibm.com/systems/info/x86servers/serverproven/compat/us> to make sure that the hardware and software is supported by your product.
- Go to <http://www.ibm.com/supportportal> to check for information to help you solve the problem.
- Gather the following information to provide to the service technician. This data will help the service technician quickly provide a solution to your problem and ensure that you receive the level of service for which you might have contracted.
  - Hardware and Software Maintenance agreement contract numbers, if applicable
  - Machine type number (Lenovo 4-digit machine identifier)
  - Model number
  - Serial number
  - Current system UEFI and firmware levels
  - Other pertinent information such as error messages and logs
- Go to [http://www.ibm.com/support/entry/portal/Open\\_service\\_request](http://www.ibm.com/support/entry/portal/Open_service_request) to submit an Electronic Service Request. Submitting an Electronic Service Request

will start the process of determining a solution to your problem by making the pertinent information available to the service technicians. The IBM service technicians can start working on your solution as soon as you have completed and submitted an Electronic Service Request.

You can solve many problems without outside assistance by following the troubleshooting procedures that Lenovo provides in the online help or in the Lenovo product documentation. The Lenovo product documentation also describes the diagnostic tests that you can perform. The documentation for most systems, operating systems, and programs contains troubleshooting procedures and explanations of error messages and error codes. If you suspect a software problem, see the documentation for the operating system or program.

## A.2 Using the Documentation

Information about your Lenovo system and preinstalled software, if any, or optional device is available in the product documentation. That documentation can include printed documents, online documents, readme files, and help files.

See the troubleshooting information in your system documentation for instructions for using the diagnostic programs. The troubleshooting information or the diagnostic programs might tell you that you need additional or updated device drivers or other software. Lenovo maintains pages on the World Wide Web where you can get the latest technical information and download device drivers and updates. To access these pages, go to <http://www.ibm.com/supportportal>.

## A.3 Getting Help and Information from the World Wide Web

Up-to-date information about Lenovo products and support is available on the World Wide Web.

On the World Wide Web, up-to-date information about Lenovo systems, optional devices, services, and support is available at <http://www.ibm.com/supportportal>. The most current version of the Flex System product documentation is available at <http://pic.dhe.ibm.com/infocenter/flexsys/information/index.jsp>

---

## A.4 Software service and support

Through IBM Support Line, you can get telephone assistance, for a fee, with usage, configuration, and software problems with your Lenovo products.

For more information about Support Line and other IBM services, see <http://www.ibm.com/services> or see <http://www.ibm.com/planetwide> for support telephone numbers. In the U.S. and Canada, call 1-800-IBM-SERV (1-800-426-7378).

## A.5 Hardware service and support

IBM is Lenovo's preferred service provider for the BladeCenter, System x, Flex System and NeXtScale System products.

You can receive hardware service through your Lenovo reseller or from IBM. To locate a reseller authorized by Lenovo to provide warranty service, go to <http://www.ibm.com/partnerworld> and click **Business Partner Locator**. For IBM support telephone numbers, see <http://www.ibm.com/planetwide>. In the U.S. and Canada, call 1-800-IBM-SERV (1-800-426-7378).

In the U.S. and Canada, hardware service and support is available 24 hours a day, 7 days a week. In the U.K., these services are available Monday through Friday, from 9 a.m. to 6 p.m.

## A.6 Taiwan product service

IBM is Lenovo's preferred service provider for the BladeCenter, System x, Flex System and NeXtScale System products. Use this information to contact IBM Taiwan product service.

台灣 IBM 產品服務聯絡方式：  
台灣國際商業機器股份有限公司  
台北市松仁路7號3樓  
電話：0800-016-888

IBM Taiwan product service contact information:

IBM Taiwan Corporation  
3F, No 7, Song Ren Rd.  
Taipei, Taiwan  
Telephone: 0800-016-888

---

## Appendix B: Notices

Lenovo may not offer the products, services, or features discussed in this document in all countries. Consult your local Lenovo representative for information on the products and services currently available in your area.

Any reference to a Lenovo product, program, or service is not intended to state or imply that only that Lenovo product, program, or service may be used. Any functionally equivalent product, program, or service that does not infringe any Lenovo intellectual property right may be used instead. However, it is the user's responsibility to evaluate and verify the operation of any other product, program, or service.

Lenovo may have patents or pending patent applications covering subject matter described in this document. The furnishing of this document does not give you any license to these patents. You can send license inquiries, in writing, to:

*Lenovo (United States), Inc.  
1009 Think Place - Building One  
Morrisville, NC 27560  
U.S.A.  
Attention: Lenovo Director of Licensing*

LENOVO PROVIDES THIS PUBLICATION "AS IS" WITHOUT WARRANTY OF ANY KIND, EITHER EXPRESS OR IMPLIED, INCLUDING, BUT NOT LIMITED TO, THE IMPLIED WARRANTIES OF NON-INFRINGEMENT, MERCHANTABILITY OR FITNESS FOR A PARTICULAR PURPOSE. Some jurisdictions do not allow disclaimer of express or implied warranties in certain transactions, therefore, this statement may not apply to you.

This information could include technical inaccuracies or typographical errors. Changes are periodically made to the information herein; these changes will be incorporated in new editions of the publication. Lenovo may make improvements and/or changes in the product(s) and/or the program(s) described in this publication at any time without notice.

The products described in this document are not intended for use in implantation or other life support applications where malfunction may result in injury or death to persons. The information contained in this document does not affect or change Lenovo product specifications or warranties. Nothing in this document shall operate as an express or implied license or indemnity under the intellectual property rights of Lenovo or third parties. All information contained in this document was obtained in specific environments and is presented as an illustration. The result obtained in other operating environments may vary.

Lenovo may use or distribute any of the information you supply in any way it believes appropriate without incurring any obligation to you.

Any references in this publication to non-Lenovo Web sites are provided for convenience only and do not in any manner serve as an endorsement of those Web sites. The materials at those Web sites are not part of the materials for this Lenovo product, and use of those Web sites is at your own risk.

---

Any performance data contained herein was determined in a controlled environment. Therefore, the result obtained in other operating environments may vary significantly. Some measurements may have been made on development-level systems and there is no guarantee that these measurements will be the same on generally available systems. Furthermore, some measurements may have been estimated through extrapolation. Actual results may vary. Users of this document should verify the applicable data for their specific environment.

## B.1 Trademarks

Lenovo, the Lenovo logo, BladeCenter, Flex System, NeXtScale System, and System x are trademarks of Lenovo in the United States, other countries, or both.

Other company, product, or service names may be trademarks or service marks of others.

## B.2 Important notes

Processor speed indicates the internal clock speed of the microprocessor; other factors also affect application performance.

CD or DVD drive speed is the variable read rate. Actual speeds vary and are often less than the possible maximum.

When referring to processor storage, real and virtual storage, or channel volume, KB stands for 1 024 bytes, MB stands for 1 048 576 bytes, and GB stands for 1 073 741 824 bytes.

When referring to hard disk drive capacity or communications volume, MB stands for 1 000 000 bytes, and GB stands for 1 000 000 000 bytes. Total user-accessible capacity can vary depending on operating environments.

Maximum internal hard disk drive capacities assume the replacement of any standard hard disk drives and population of all hard-disk-drive bays with the largest currently supported drives that are available from Lenovo.

Maximum memory might require replacement of the standard memory with an optional memory module.

Each solid-state memory cell has an intrinsic, finite number of write cycles that the cell can incur. Therefore, a solid-state device has a maximum number of write cycles that it can be subjected to, expressed as total bytes written (TBW). A device that has exceeded this limit might fail to respond to system-generated commands or might be incapable of being written to. Lenovo is not responsible for replacement of a device that has exceeded its maximum guaranteed number of program/erase cycles, as documented in the Official Published Specifications for the device.

Lenovo makes no representations or warranties with respect to non-Lenovo products. Support (if any) for the non-Lenovo products is provided by the third party, not Lenovo.

Some software might differ from its retail version (if available) and might not include user manuals or all program functionality.

### **B.3 Recycling information**

Lenovo encourages owners of information technology (IT) equipment to responsibly recycle their equipment when it is no longer needed. Lenovo offers a variety of programs and services to assist equipment owners in recycling their IT products. For information on recycling Lenovo products, go to:

<http://www.lenovo.com/recycling>

### **B.4 Telecommunication regulatory statement**

This product may not be certified in your country for connection by any means whatsoever to interfaces of public telecommunications networks. Further certification may be required by law prior to making any such connection. Contact a Lenovo representative or reseller for any questions.

### **B.5 Electronic emission notices**

When you attach a monitor to the equipment, you must use the designated monitor cable and any interference suppression devices that are supplied with the monitor.

#### **B.5.1 Federal Communications Commission (FCC) statement**

**Note:** This equipment has been tested and found to comply with the limits for a Class A digital device, pursuant to Part 15 of the FCC Rules. These limits are designed to provide reasonable protection against harmful interference when the equipment is operated in a commercial environment. This equipment generates, uses, and can radiate radio frequency energy and, if not installed and used in accordance with the instruction manual, may cause harmful interference to radio communications. Operation of this equipment in a residential area is likely to cause harmful interference, in which case the user will be required to correct the interference at his own expense.

Properly shielded and grounded cables and connectors must be used in order to meet FCC emission limits. Lenovo is not responsible for any radio or television interference caused by using other than recommended cables and connectors or by unauthorized changes or modifications to this equipment. Unauthorized changes or modifications could void the user's authority to operate the equipment.

This device complies with Part 15 of the FCC Rules. Operation is subject to the following two conditions: (1) this device may not cause harmful interference, and (2) this device must accept any interference received, including interference that might cause undesired operation.

### **B.5.2 Industry Canada Class A emission compliance statement**

This Class A digital apparatus complies with Canadian ICES-003.

### **Avis de conformité à la réglementation d'Industrie Canada**

Cet appareil numérique de la classe A est conforme à la norme NMB-003 du Canada.

### **B.5.3 Australia and New Zealand Class A statement**

**Attention:** This is a Class A product. In a domestic environment this product may cause radio interference in which case the user may be required to take adequate measures.

### **B.5.4 European Union EMC Directive conformance statement**

This product is in conformity with the protection requirements of EU Council Directive 2004/108/EC on the approximation of the laws of the Member States relating to electromagnetic compatibility. Lenovo cannot accept responsibility for any failure to satisfy the protection requirements resulting from a non-recommended modification of the product, including the installation of option cards from other manufacturers.

This product has been tested and found to comply with the limits for Class A Information Technology Equipment according to European Standard EN 55022. The limits for Class A equipment were derived for commercial and industrial environments to provide reasonable protection against interference with licensed communication equipment.

Lenovo, Einsteinova 21, 851 01 Bratislava, Slovakia



---

## B.5.5 Germany Class A statement

**Deutschsprachiger EU Hinweis: Hinweis für Geräte der Klasse A EU-Richtlinie zur Elektromagnetischen Verträglichkeit**

**Deutschsprachiger EU Hinweis: Hinweis für Geräte der Klasse A EU-Richtlinie zur Elektromagnetischen Verträglichkeit** Dieses Produkt entspricht den Schutzanforderungen der EU-Richtlinie 2004/108/EG (früher 89/336/EWG) zur Angleichung der Rechtsvorschriften über die elektromagnetische Verträglichkeit in den EU-Mitgliedsstaaten und hält die Grenzwerte der EN 55022 Klasse A ein.

Um dieses sicherzustellen, sind die Geräte wie in den Handbüchern beschrieben zu installieren und zu betreiben. Des Weiteren dürfen auch nur von der Lenovo empfohlene Kabel angeschlossen werden. Lenovo übernimmt keine Verantwortung für die Einhaltung der Schutzanforderungen, wenn das Produkt ohne Zustimmung der Lenovo verändert bzw. wenn Erweiterungskomponenten von Fremdherstellern ohne Empfehlung der Lenovo gesteckt/eingebaut werden.

**Deutschland:**

**Einhaltung des Gesetzes über die elektromagnetische Verträglichkeit von Betriebsmitteln** Dieses Produkt entspricht dem „Gesetz über die elektromagnetische Verträglichkeit von Betriebsmitteln“ EMVG (früher „Gesetz über die elektromagnetische Verträglichkeit von Geräten“). Dies ist die Umsetzung der EU-Richtlinie 2004/108/EG (früher 89/336/EWG) in der Bundesrepublik Deutschland.

**Zulassungsbescheinigung laut dem Deutschen Gesetz über die elektromagnetische Verträglichkeit von Betriebsmitteln, EMVG vom 20. Juli 2007 (früher Gesetz über die elektromagnetische Verträglichkeit von Geräten), bzw. der EMV EG Richtlinie 2004/108/EC (früher 89/336/EWG), für Geräte der Klasse A.**

Dieses Gerät ist berechtigt, in Übereinstimmung mit dem Deutschen EMVG das EG-Konformitätszeichen - CE - zu führen. Verantwortlich für die Konformitätserklärung nach Paragraf 5 des EMVG ist die Lenovo (Deutschland) GmbH, Gropiusplatz 10, D-70563 Stuttgart.

Informationen in Hinsicht EMVG Paragraf 4 Abs. (1) 4: **Das Gerät erfüllt die Schutzanforderungen nach EN 55024 und EN 55022 Klasse A.**

Nach der EN 55022: „Dies ist eine Einrichtung der Klasse A. Diese Einrichtung kann im Wohnbereich Funkstörungen verursachen; in diesem Fall kann vom Betreiber verlangt werden, angemessene Maßnahmen durchzuführen und dafür aufzukommen.“

Nach dem EMVG: „Geräte dürfen an Orten, für die sie nicht ausreichend entstört sind, nur mit besonderer Genehmigung des Bundesministers für Post und Telekommunikation oder des Bundesamtes für Post und Telekommunikation betrieben werden. Die Genehmigung wird erteilt, wenn keine elektromagnetischen Störungen zu erwarten sind.“ (Auszug aus dem EMVG, Paragraph 3, Abs. 4). Dieses Genehmigungsverfahren ist nach Paragraph 9 EMVG in Verbindung mit der entsprechenden Kostenverordnung (Amtsblatt 14/93) kostenpflichtig.

Anmerkung: Um die Einhaltung des EMVG sicherzustellen sind die Geräte, wie in den Handbüchern angegeben, zu installieren und zu betreiben.

## B.5.6 Japan VCCI Class A statement

この装置は、クラス A 情報技術装置です。この装置を家庭環境で使用すると電波妨害を引き起こすことがあります。この場合には使用者が適切な対策を講ずるよう要求されることがあります。  
VCCI-A

This is a Class A product based on the standard of the Voluntary Control Council for Interference (VCCI). If this equipment is used in a domestic environment, radio interference may occur, in which case the user may be required to take corrective actions.

## B.5.7 Korea Communications Commission (KCC) statement

이 기기는 업무용(A급)으로 전자파적합기기로서 판매자 또는 사용자는 이 점을 주의하시기 바라며, 가정외의 지역에서 사용하는 것을 목적으로 합니다.

This is electromagnetic wave compatibility equipment for business (Type A). Sellers and users need to pay attention to it. This is for any areas other than home.

## B.5.8 Russia Electromagnetic Interference (EMI) Class A statement

ВНИМАНИЕ! Настоящее изделие относится к классу А. В жилых помещениях оно может создавать радиопомехи, для снижения которых необходимы дополнительные меры

## B.5.9 People's Republic of China Class A electronic emission statement

中华人民共和国“A类”警告声明

声明  
此为A级产品，在生活环境中，该产品可能会造成无线电干扰。在这种情况下，可能需要用户对其干扰采取切实可行的措施。

## B.5.10 Taiwan Class A compliance statement

警告使用者：  
這是甲類的資訊產品，在居住的環境中使用時，可能會造成射頻干擾，在這種情況下，使用者會被要求採取某些適當的對策。