

Lenovo ThinkSystem NE2572 RackSwitch

ONIE User Guide

for Lenovo Cloud Network Operating System

LenovoTM

Note: Before using this information and the product it supports, read the general information in the *Safety information and Environmental Notices* and *User Guide* documents on the *Lenovo Documentation CD*, and the *Warranty Information* document that comes with the product.

Second Edition (January 2018)

© Copyright Lenovo 2018

LIMITED AND RESTRICTED RIGHTS NOTICE: If data or software is delivered pursuant a General Services Administration "GSA" contract, use, reproduction, or disclosure is subject to restrictions set forth in Contract No. GS-35F-05925.

Lenovo and the Lenovo logo are trademarks of Lenovo in the United States, other countries, or both.

Contents

Overview	5
Connecting to the NE2572	6
Switch Unit	6
Serial Console Port	7
ONIE on the NE2572	8
ONIE Activation	9
Installing ONIE	12
Booting in ONIE Mode	14
Booting in ONIE Install Mode	15
Booting in ONIE Update Mode	16
Booting in ONIE Uninstall Mode	18
Booting in ONIE Rescue Mode	18
The Grub Menu	19
The BIOS Menu	20
Uninstalling the Lenovo Network OS	22
Using ONIE without Lenovo Network OS	23
Getting Help and Technical Assistance	25
Notices	27
Trademarks	29
Important Notes	30
Recycling Information	31
Particulate Contamination	32
Telecommunication Regulatory Statement	33
Electronic Emission Notices	34
Federal Communications Commission (FCC) Statement	34
Industry Canada Class A Emission Compliance Statement	34
Avis de Conformité à la Réglementation d'Industrie Canada	34
Australia and New Zealand Class A Statement	34
European Union - Compliance to the Electromagnetic Compatibility Directive	35
Germany Class A Statement	35
Japan VCCI Class A Statement	36
Japan Electronics and Information Technology Industries Association (JEITA) Statement	36
Korea Communications Commission (KCC) Statement	37
Russia Electromagnetic Interference (EMI) Class A statement	37
People's Republic of China Class A electronic emission statement	37
Taiwan Class A compliance statement	37

Overview

The Open Network Install Environment (ONIE) is a small Linux-based operating system that provides an open install environment for network switches without operating systems.

ONIE enables a network switch ecosystem where end-users can choose among different Network Operating Systems (NOS). Practically, ONIE boots on a switch, discovers NOS installer images available on the local network or on a USB drive, copies the chosen image to the switch, and provides an environment where the installer can load the NOS onto the switch.

ONIE is classified as free software, meaning it can be redistributed and/or modified under the terms of version 2 of the GNU General Public License as published by the Free Software Foundation. To read the license, visit the following link:

<https://github.com/opencomputeproject/onie/blob/master/COPYING>

For more details about ONIE, go to onie.org.

Lenovo ONIE Image

To download the Lenovo ONIE image, visit the following website:

<http://support.lenovo.com/>

The ONIE images for the NE2572 have the [ONIE] tag in their name, as follows:

Lenovo ThinkSystem NE2572 RackSwitch [ONIE] Firmware Update
v10.x.x.0

Open-Source ONIE Image

To download an open-source ONIE image, go to the following link:

https://github.com/lenovo/networking-onie/tree/master/lenovo_ne2572

The image `onie-recovery-x86_64-lenovo_ne2572-r0.iso` can be used to install ONIE on a switch that does not already have ONIE installed.

The image `onie-updater-x86_64-lenovo_ne2572-r0` can be used to update previously installed ONIE images on a switch.

Connecting to the NE2572

This section describes how to connect to the Lenovo ThinkSystem NE2572 RackSwitch. For more details about the switch and on how to install the switch hardware, consult the *Lenovo ThinkSystem NE2572 RackSwitch Installation Guide*.

Switch Unit

The NE2572 is a 1U GbE switch and it can be rack-mounted in a horizontal position. The following illustrations show the features on the front and rear panels of the switch:

Figure 1. NE2572 front panel

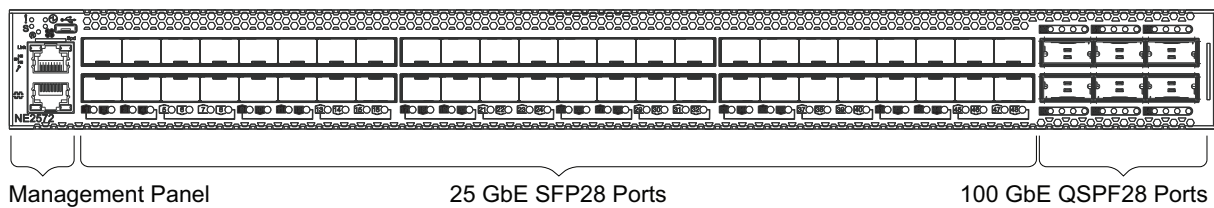

Figure 2. NE2572 management panel detail

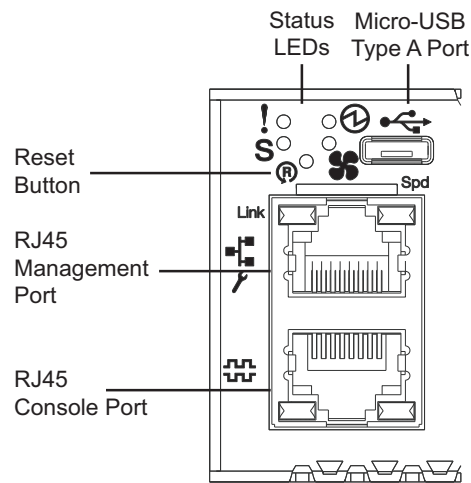
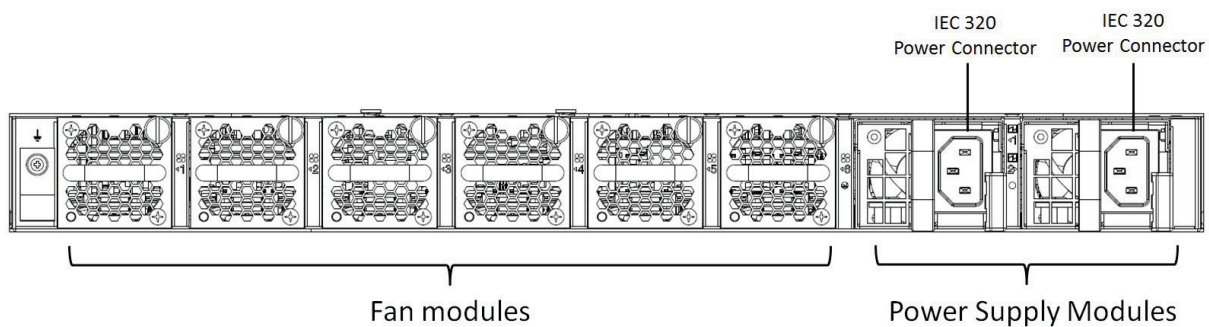

Figure 3. NE2572 rear panel



Serial Console Port

The RJ45 console port on the front management panel is available for switch console management. The port operates using RS-232 serial communications. A compatible console cable kit is included with the switch.

To connect a computer or terminal to the switch using the included kit, connect one end of the Category 5 patch cable to the RJ45 console port of the switch and the other end of the patch cable to the RJ45-to-DB9 adapter, which connects to the computer or terminal (see the following illustration).

Figure 4. Console cable connection

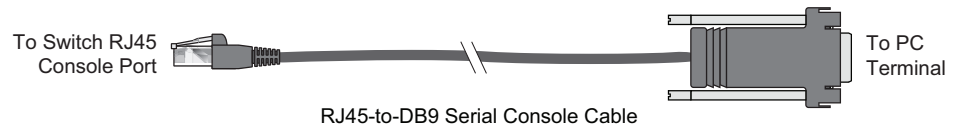

The computer or terminal must run a terminal emulator (for example, SecureCRT, HyperTerminal, or PuTTY). The console port terminal emulation requirements are as follows:

- Default baud rate: 115,200 bps
- Character size: 8 characters
- Parity: none
- Stop bits: 1
- Data bits: 8
- Flow control: none

ONIE on the NE2572

The Lenovo ThinkSystem NE2572 RackSwitch comes out of the box with Lenovo Cloud Network OS (CNOS) already installed on the switch.

The switch also has ONIE pre-installed, however to ensure maximum security it is deactivated by default. To enable ONIE on the switch, see [“ONIE Activation” on page 9](#).

3. After entering the BIOS menu, navigate to the “Security” tab.

```

Aptio Setup Utility - Copyright (C) 2017 American Megatrends, Inc.
Main Advanced Event Logs Security Boot Save & Exit
-----
|
| If ONLY the Administrator's password is set,
| then this only limits access to Setup and is
| only asked for when entering Setup.
| If ONLY the User's password is set, then this
| is a power on password and must be entered to
| boot or enter Setup. In Setup the User will
| have Administrator rights.
| The password length must be
| in the following range:
| Minimum length      3
| Maximum length     20
|
| Administrator Password
| User Password
|
| > Secure Boot menu
| > Secure Flash update
|
|-----
| ^|Customizable Secure
| +|Boot settings
| *|
| *|
| *|
| *|
| *|
| *|
| *|
| *|-----
| *|><: Select Screen
| *|^v: Select Item
| *|Enter: Select
| *|+/-: Change Opt.
| *|F1: General Help
| *|F2: Previous Values
| *|F3: Optimized Defaults
| *|F4: Save & Exit
| v|ESC: Exit
|-----
Version 2.17.1245. Copyright (C) 2017 American Megatrends, Inc.

```

4. Select “Secure Boot menu”.

```

Aptio Setup Utility - Copyright (C) 2017 American Megatrends, Inc.
Security
-----
|
| System Mode      User
| Secure Boot     Not Active
|
| Secure Boot     [Enabled]
| Secure Boot Mode [Custom]
| > Key Management
|
|-----
| |Secure Boot can be
| |enabled if 1.System
| |running in User mode
| |with enrolled Platform
| |Key(PK) 2.CSM function
| |is disabled
|
|-----
| |><: Select Screen
| |^v: Select Item
| |Enter: Select
| |+/-: Change Opt.
| |F1: General Help
| |F2: Previous Values
| |F3: Optimized Defaults
| |F4: Save & Exit
| |ESC: Exit
|-----
Version 2.17.1245. Copyright (C) 2017 American Megatrends, Inc.

```

5. Select the “Secure Boot” setting and change it from [Enabled] to [Disabled].

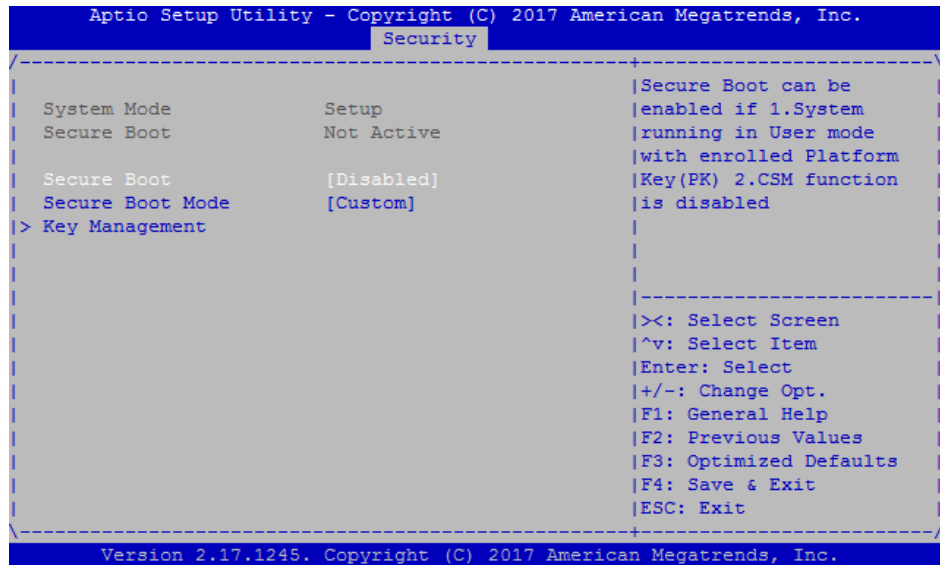

6. Press **F4** to save the changes and exit the BIOS menu. The switch reloads and then runs with secure boot disabled.

After the reloading process is complete, ONIE is activated on the switch. This means you can now boot the switch into an ONIE mode. For more details, see [“Booting in ONIE Mode” on page 14](#).

Note: To deactivate ONIE, follow the previous steps, except at Step 4 change the “Secure Boot” setting from [Disabled] to [Enabled].

Installing ONIE

The ThinkSystem NE2572 RackSwitch comes out of the box with ONIE pre-installed.

If you have removed ONIE from the switch, you can use the following steps to reinstall it:

1. Download the ONIE image for the NE2572 from the following link:

<http://support.lenovo.com/>

The ONIE image for the NE2572 is called:

`onie-recovery-x86_64-lenovo_ne2572-r0.iso`

2. Create a bootable USB flash drive using the downloaded ONIE image by following these steps:

- Download and install an utility that allows you to create a bootable USB flash drive. For example, you can use Rufus:

<https://rufus.akeo.ie/>

- Launch Rufus and navigate to the “Create a bootable disk using” setting. Click on the icon to the far right and select the previously downloaded ONIE image.
- Select “DD Image” from the drop down list next to the “Create a bootable disk using” setting.
- Click the “Start” button and agree with any prompts that appear.

Your USB flash drive is now ready to boot ONIE.

3. Plug in the bootable USB device into the switch using the USB convertor cable that comes in the box with the NE2572.
4. Connect to the switch using the mini-USB serial console port and disable “Secure Boot” as shown in “[ONIE Activation](#)” on page 9, steps 1 through 6.
5. Enter the BIOS menu again, as described in “[ONIE Activation](#)” - Step 2.

6. Navigate to the "Save & Exit" tab.

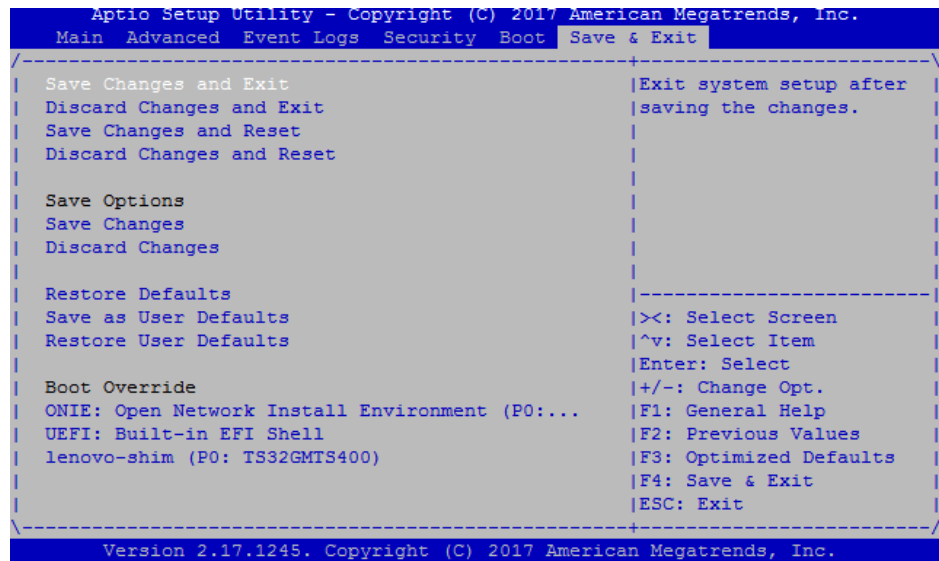

7. Select the "Boot Override" setting and change it by selecting your USB flash drive.
8. A menu appears presenting two ONIE install options. Select the second option, "ONIE: Embed ONIE".



ONIE boots from the USB flash drive, installs itself on the switch, and then reloads the NE2572.

Booting in ONIE Mode

After you activate ONIE, you can boot the switch in ONIE mode. ONIE offers four modes for booting, each providing a different operation:

- ONIE install mode
- ONIE rescue mode
- ONIE uninstall mode
- ONIE update mode

There are three ways to boot the switch in an ONIE mode:

- using the Command Line Interface (CLI):
 - **startup image onie-image install**
 - **startup image onie-image rescue**
 - **startup image onie-image uninstall**
 - **startup image onie-image update**
- using the Grub Menu that appears during startup (for more details, see [“The Grub Menu” on page 19](#))
- using the BIOS Menu (for more details, see [“The BIOS Menu” on page 20](#))

Note: For the NE2572, the CLI commands for booting in different ONIE modes display an error if secure boot is not disabled on the switch. To disable secure boot, see [“ONIE Activation” on page 9](#).

The following pages describe the four ONIE modes and how the CLI commands can be used to boot the switch in each mode.

Booting in ONIE Install Mode

This mode is used to install a NOS using ONIE. The ONIE install mode boots the ONIE kernel and file-system and executes the ONIE discovery process. The discovery process uses a number of different mechanisms to find a NOS installer program.

Once a NOS installer is found, it is downloaded and executed. The installer loads the Network OS on the switch, updates required ONIE environment variables, and reboots the switch.

The switch now runs its newly installed Network OS and behaves like a regular switch. The user can, at any point, reboot and run the ONIE installer again to install another Network OS.

The Lenovo ONIE installer image, which installs the different Lenovo Network Operating Systems, is called `onie-installer-x86_64-lenovo_ne2572-r0`, and it is available at the following link:

<http://support.lenovo.com/>

To boot the switch in ONIE install mode on the next reload, use the following command from the switch CLI:

```
NE2572(config)# startup image onie-image install
```

To check which ONIE mode the switch is configured to boot in, use the following command from the switch CLI:

```
NE2572# display boot

Current ZTP State: Enable
Current FLASH software:
  active image: version 10.4.1.0
  standby image: version 0.0.0.0
  Uboot: version 10.4.1.0
  ONIE: version unknown, downloaded unknown
Currently set to boot ONIE rescue mode
Currently scheduled reboot time: none
Current port mode: default mode
```

Booting in ONIE Update Mode

ONIE update mode installs a new version of ONIE on the switch, including the Linux kernel. It works similarly to the ONIE install mode, except the discovery process searches for an ONIE image instead, and not a NOS image.

Notes:

- This only upgrades the ONIE partition on the switch and does not affect the NOS image.

The ONIE updater image is called
`onie-updater-x86_64-lenovo_ne2572-r0`.

- After updating ONIE, the boot priority must be changed from the BIOS menu to enable the switch to run Cloud NOS:
 - You can interrupt the startup process of the switch and enter the BIOS menu from the serial console port. When the system displays the following message, press **Delete** or **Esc**.

```
Press <DEL> (Terminal Not applicable) or <ESC> to enter setup...
```

The BIOS menu appears.

```
Aptio Setup Utility - Copyright (C) 2017 American Megatrends, Inc.
Main Advanced Event Logs Security Boot Save & Exit

|-----|
| BIOS Information | Choose the system |
| BIOS Vendor      | American Megatrends | default language |
| Core Version     | 5.009                |                   |
| Compliance       | UEFI 2.3; PI 1.2     |                   |
| Project Version  | 0ACBZ 0.33 x64       |                   |
| Build Date and Time | 05/10/2017 11:09:14 |                   |
|-----|
| Memory Information |                   |
| Total Memory      | 8192 MB (DDR3)       |                   |
|-----|
| OEM Version       | ALPHA.05.33.0206B    |                   |
| System Language   | [English]            |                   |
|-----|
| System Date       | [Thu 05/11/2017]     |                   |
| System Time       | [11:13:37]           |                   |
|-----|
| Access Level      | Administrator        |                   |
|-----|
|><: Select Screen |
|^v: Select Item   |
|Enter: Select     |
|+/-: Change Opt. |
|F1: General Help |
|F2: Previous Values |
|F3: Optimized Defaults |
|F4: Save & Exit   |
|ESC: Exit         |
|-----|
Version 2.17.1245. Copyright (C) 2017 American Megatrends, Inc.
```

- o Navigate to the "Boot" tab.

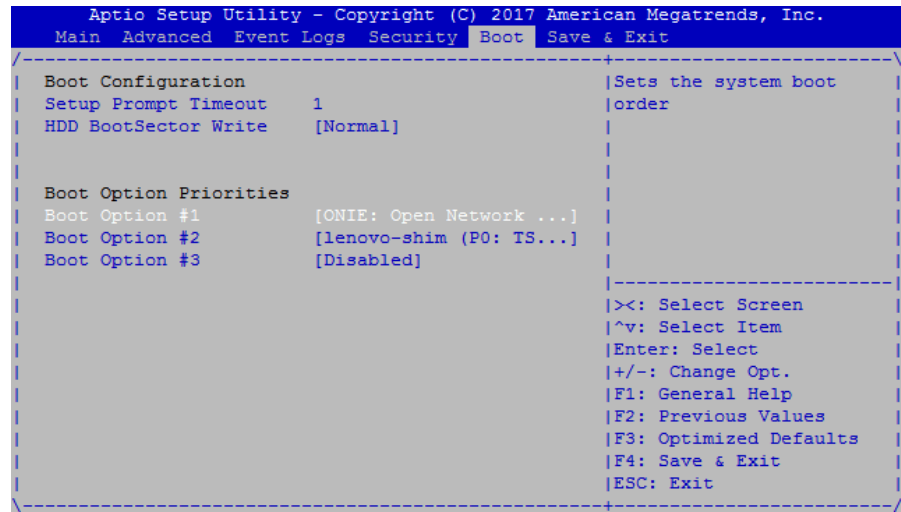

- o Select the "Boot Option #1" from ONIE to lenovo-shim.

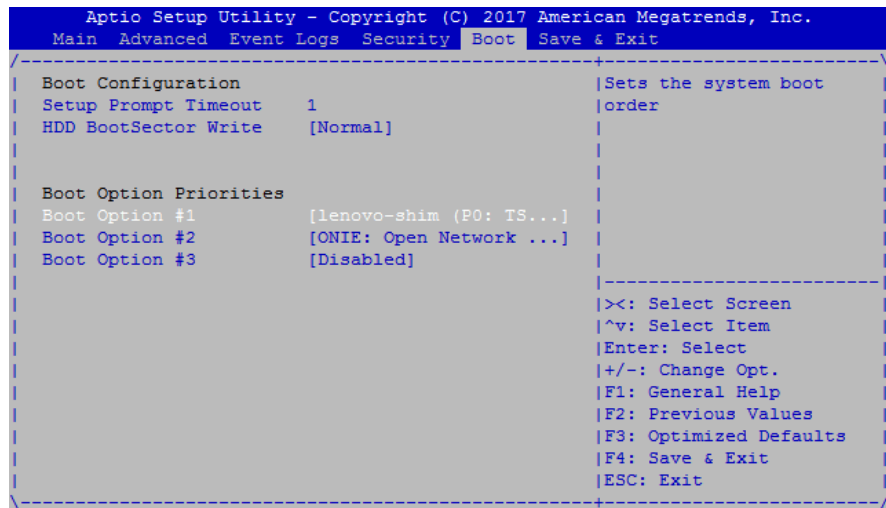

To boot the switch in ONIE update mode on the next reload, use the following command from the switch CLI:

```
NE2572(config)# startup image onie-image update
```

Note: Upon reloading after the update process is completed, the switch is not able to load the Lenovo Network OS, booting into ONIE Install mode instead.

Booting in ONIE Uninstall Mode

This mode is used to uninstall a NOS using ONIE. The ONIE uninstall mode boots the ONIE kernel and deletes the NOS image running on the switch. After the uninstall is complete, the switch automatically reloads and boots into ONIE install mode.

To boot the switch in ONIE uninstall mode on the next reload, use the following command from the switch CLI:

```
NE2572(config)# startup image onie-image uninstall
```

Note: The following warning is displayed after choosing ONIE uninstall mode. You are prompted for confirmation:

```
WARNING: Booting ONIE in uninstall mode will completely uninstall the
operating system!
Only the ONIE image will be preserved.
Are you sure you want the next boot to uninstall the OS? (y/n)
```

Once you confirm, the switch boots in ONIE uninstall mode on the next reload. For more details, see [“Uninstalling the Lenovo Network OS” on page 22](#).

Booting in ONIE Rescue Mode

ONIE rescue mode is useful when trying to recover from a broken NOS image. It works similarly to the ONIE install mode, except the ONIE discovery process is disabled. ONIE will not try to find and install a NOS image. This allows for the troubleshooting of the system.

To boot the switch in ONIE rescue mode on the next reload, use the following command from the switch CLI:

```
NE2572(config)# startup image onie-image rescue
```

The Grub Menu

The Grub menu is another way to access ONIE and configure the switch to boot into different ONIE modes. It appears on the screen automatically during the switch startup process.

```
GNU GRUB  version 2.00
-----
CNOS slot 1
CNOS slot 2
ONIE

Use the ^ and v keys to select which entry is highlighted.
Press enter to boot the selected OS, `e' to edit the commands
before booting or `c' for a command-line. ESC to return
previous menu.
```

ONIE can be configured to run on the switch by using the arrow keys and selecting the “ONIE” option from the menu by pressing **Enter**.

After this step, select an ONIE mode from the list.

```
GNU GRUB  version 2.02~beta3
-----
*ONIE: Install OS
ONIE: Rescue
ONIE: Uninstall OS
ONIE: Update ONIE
ONIE: Embed ONIE

Use the ^ and v keys to select which entry is highlighted.
Press enter to boot the selected OS, `e' to edit the commands
before booting or `c' for a command-line.
```

To successfully boot into an ONIE mode from the Grub menu, you must reload the switch with Secure Boot disabled. For details on how to disable Secure Boot, see [“ONIE Activation” on page 9](#).

For mode details on the different ONIE modes, see [“Booting in ONIE Mode” on page 14](#).

After selecting an ONIE mode, the switch reloads using that mode.

The BIOS Menu

The Basic Input/Output System (BIOS) menu is another way to access ONIE and configure the switch to boot into different ONIE modes.

Use the following steps to select an ONIE mode:

1. Disable “Secure Boot” as shown in “[ONIE Activation](#)”, steps 1 through 5.
2. Press **Esc** and navigate to the “Boot” tab.

```
Aptio Setup Utility - Copyright (C) 2017 American Megatrends, Inc.
Main Advanced Event Logs Security Boot Save & Exit

Boot Configuration | Sets the system boot
Setup Prompt Timeout 1 | order
HDD BootSector Write [Normal]

Boot Option Priorities
Boot Option #1 [lenovo-shim (P0: TS...)]
Boot Option #2 [ONIE: Open Network ...]
Boot Option #3 [Disabled]

|><: Select Screen
|^v: Select Item
|Enter: Select
|+/-: Change Opt.
|F1: General Help
|F2: Previous Values
|F3: Optimized Defaults
|F4: Save & Exit
|ESC: Exit

Version 2.17.1245. Copyright (C) 2017 American Megatrends, Inc.
```

3. Select the “Boot Option #1” setting and change it to [ONIE: Open Network Install Environment].

```
Aptio Setup Utility - Copyright (C) 2017 American Megatrends, Inc.
Main Advanced Event Logs Security Boot Save & Exit

Boot Configuration | Sets the system boot
Setup Prompt Timeout 1 | order
HDD BootSector Write [Normal]

Boot Option Priorities
Boot Option #1 [ONIE: Open Network ...]
Boot Option #2 [lenovo-shim (P0: TS...)]
Boot Option #3 [Disabled]

|><: Select Screen
|^v: Select Item
|Enter: Select
|+/-: Change Opt.
|F1: General Help
|F2: Previous Values
|F3: Optimized Defaults
|F4: Save & Exit
|ESC: Exit

Version 2.17.1245. Copyright (C) 2017 American Megatrends, Inc.
```

4. Press **F4** to save the changes and exit the BIOS menu. The switch reloads and then runs with secure boot disabled and boots ONIE.
5. A menu appears from which you can select an ONIE mode.

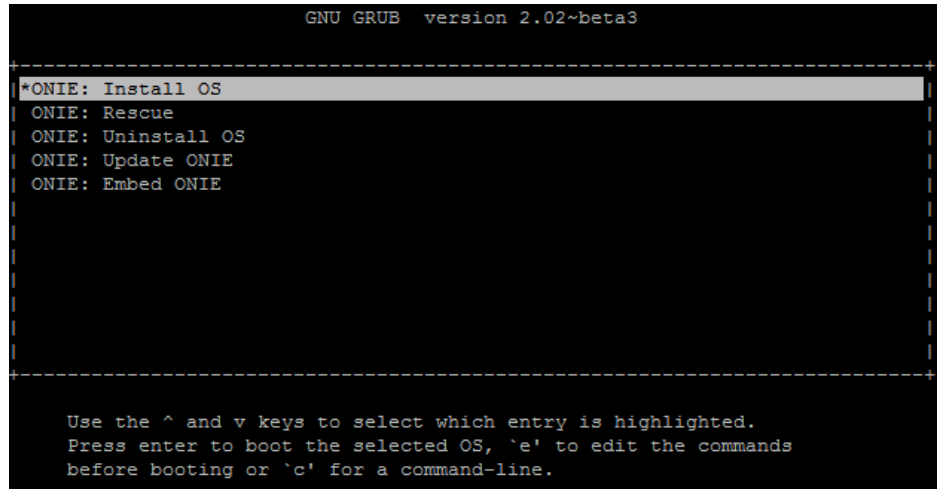

The switch reloads using the selected ONIE mode. For details on the different ONIE modes, see [“Booting in ONIE Mode” on page 14](#).

Uninstalling the Lenovo Network OS

If you wish to run another network operating system (NOS), you can uninstall the *Lenovo Network OS* by using the ONIE Uninstall mode. For more details, see [“Booting in ONIE Uninstall Mode” on page 18](#).

Notes:

- If ONIE is not installed on the switch, you must first set it up on the networking device. For more details, see [“Installing ONIE” on page 12](#).
- Once you uninstall the *Lenovo Network OS* from the network device, see [“Using ONIE without Lenovo Network OS” on page 23](#).

After booting in ONIE Uninstall mode, the following is displayed:

```
Loading Open Network Install Environment ...
Platform: -lenovo_ne2572-r0
Version : lenovo-internal
...

discover: Uninstall mode detected. Running uninstaller.
Erasing u-boot environment NOR flash region
Erasing 128 Kibyte @ 20000 - 100% complete.
Erasing internal mass storage device: /dev/mmcblk0 (7631MB)
  Percent complete: 100%
Erase complete.
Uninstall complete. Rebooting...
discover: Uninstall mode detected. No discover stopped.
Stopping: dropbear ssh daemon... done.
Stopping: telnetd... done.
Stopping: syslogd... done.
Info: Unmounting kernel filesystems
The system is going down NOW!
Sent SIGTERM to all processes
Sent SIGKILL to all processes
Requesting system reboot
Restarting system.
...
discover: installer mode detected. Running installer.
Starting: discover... done.

Please press Enter to activate this console. Info: eth0: Checking
link... up.
Info: Trying DHCPv4 on interface: eth0
Warning: Unable to configure interface using DHCPv4: eth0
ONIE: Using default IPv4 addr: eth0: 192.168.3.10/24
ONIE: Using link-local IPv4 addr: eth0: 169.254.166.99/16
ONIE: Starting ONIE Service Discovery
```

Once the NOS uninstall process is complete, the switch is reloaded and configured to boot in ONIE Install mode.

Using ONIE without Lenovo Network OS

If you remove the Lenovo Network OS from the switch by using ONIE Uninstall mode, we recommend that you consult the official documentation from the ONIE website:

<https://github.com/opencomputeproject/onie/wiki/Quick-Start-Guide>

If you run into trouble with an ONIE-based installation, follow the suggestions from the ONIE website:

<https://github.com/opencomputeproject/onie/wiki/Quick-Start-Guide#debugging-an-installation>

Appendix A. Getting Help and Technical Assistance

If you need help, service, or technical assistance or just want more information about Lenovo products, you will find a wide variety of sources available from Lenovo to assist you.

Use this information to obtain additional information about Lenovo and Lenovo products, and determine what to do if you experience a problem with your Lenovo system or optional device.

Note: This section includes references to IBM web sites and information about obtaining service. IBM is Lenovo's preferred service provider for the System x, Flex System, and NeXtScale System products.

Before you call, make sure that you have taken these steps to try to solve the problem yourself.

If you believe that you require warranty service for your Lenovo product, the service technicians will be able to assist you more efficiently if you prepare before you call.

- Check all cables to make sure that they are connected.
- Check the power switches to make sure that the system and any optional devices are turned on.
- Check for updated software, firmware, and operating-system device drivers for your Lenovo product. The Lenovo Warranty terms and conditions state that you, the owner of the Lenovo product, are responsible for maintaining and updating all software and firmware for the product (unless it is covered by an additional maintenance contract). Your service technician will request that you upgrade your software and firmware if the problem has a documented solution within a software upgrade.
- If you have installed new hardware or software in your environment, check the [Lenovo Support portal](#) to make sure that the hardware and software is supported by your product., and where you can check for information to help you solve the problem.
- Gather the following information to provide to the service technician. This data will help the service technician quickly provide a solution to your problem and ensure that you receive the level of service for which you might have contracted.
 - Hardware and Software Maintenance agreement contract numbers, if applicable
 - Machine type number (if applicable—Lenovo 4-digit machine identifier)
 - Model number
 - Serial number
 - Current system UEFI and firmware levels
 - Other pertinent information such as error messages and logs
- Start the process of determining a solution to your problem by making the pertinent information available to the service technicians. The IBM service technicians can start working on your solution as soon as you have completed and submitted an Electronic Service Request.

You can solve many problems without outside assistance by following the troubleshooting procedures that Lenovo provides in the online help or in the Lenovo product documentation. The Lenovo product documentation also describes the diagnostic tests that you can perform. The documentation for most systems, operating systems, and programs contains troubleshooting procedures and explanations of error messages and error codes. If you suspect a software problem, see the documentation for the operating system or program.

Appendix B. Notices

Lenovo may not offer the products, services, or features discussed in this document in all countries. Consult your local Lenovo representative for information on the products and services currently available in your area.

Any reference to a Lenovo product, program, or service is not intended to state or imply that only that Lenovo product, program, or service may be used. Any functionally equivalent product, program, or service that does not infringe any Lenovo intellectual property right may be used instead. However, it is the user's responsibility to evaluate and verify the operation of any other product, program, or service.

Lenovo may have patents or pending patent applications covering subject matter described in this document. The furnishing of this document does not give you any license to these patents. You can send license inquiries, in writing, to:

Lenovo (United States), Inc.
1009 Think Place - Building One
Morrisville, NC 27560
U.S.A.

Attention: Lenovo Director of Licensing

LENOVO PROVIDES THIS PUBLICATION "AS IS" WITHOUT WARRANTY OF ANY KIND, EITHER EXPRESS OR IMPLIED, INCLUDING, BUT NOT LIMITED TO, THE IMPLIED WARRANTIES OF NON-INFRINGEMENT, MERCHANTABILITY OR FITNESS FOR A PARTICULAR PURPOSE. Some jurisdictions do not allow disclaimer of express or implied warranties in certain transactions, therefore, this statement may not apply to you.

This information could include technical inaccuracies or typographical errors. Changes are periodically made to the information herein; these changes will be incorporated in new editions of the publication. Lenovo may make improvements and/or changes in the product(s) and/or the program(s) described in this publication at any time without notice.

The products described in this document are not intended for use in implantation or other life support applications where malfunction may result in injury or death to persons. The information contained in this document does not affect or change Lenovo product specifications or warranties.

Nothing in this document shall operate as an express or implied license or indemnity under the intellectual property rights of Lenovo or third parties. All information contained in this document was obtained in specific environments and is presented as an illustration. The result obtained in other operating environments may vary.

Lenovo may use or distribute any of the information you supply in any way it believes appropriate without incurring any obligation to you.

Any references in this publication to non-Lenovo Web sites are provided for convenience only and do not in any manner serve as an endorsement of those Web sites. The materials at those Web sites are not part of the materials for this Lenovo product, and use of those Web sites is at your own risk.

Any performance data contained herein was determined in a controlled environment. Therefore, the result obtained in other operating environments may vary significantly. Some measurements may have been made on development-level systems and there is no guarantee that these measurements will be the same on generally available systems. Furthermore, some measurements may have been estimated through extrapolation. Actual results may vary. Users of this document should verify the applicable data for their specific environment.

Trademarks

Lenovo, the Lenovo logo, Flex System, System x, NeXtScale System, and X-Architecture are trademarks of Lenovo in the United States, other countries, or both.

Intel and Intel Xeon are trademarks of Intel Corporation in the United States, other countries, or both.

Internet Explorer, Microsoft, and Windows are trademarks of the Microsoft group of companies.

Linux is a registered trademark of Linus Torvalds.

Other company, product, or service names may be trademarks or service marks of others.

Important Notes

Processor speed indicates the internal clock speed of the microprocessor; other factors also affect application performance.

CD or DVD drive speed is the variable read rate. Actual speeds vary and are often less than the possible maximum.

When referring to processor storage, real and virtual storage, or channel volume, KB stands for 1,024 bytes, MB stands for 1,048,576 bytes and GB stands for 1,073,741,824 bytes.

When referring to hard disk drive capacity or communications volume, MB stands for 1,000,000 bytes and GB stands for 1,000,000,000 bytes. Total user-accessible capacity can vary depending on operating environments.

Maximum internal hard disk drive capacities assume the replacement of any standard hard disk drives and population of all hard-disk-drive bays with the largest currently supported drives that are available from Lenovo.

Maximum memory might require replacement of the standard memory with an optional memory module.

Each solid-state memory cell has an intrinsic, finite number of write cycles that the cell can incur. Therefore, a solid-state device has a maximum number of write cycles that it can be subjected to, expressed as total bytes written (TBW). A device that has exceeded this limit might fail to respond to system-generated commands or might be incapable of being written to. Lenovo is not responsible for replacement of a device that has exceeded its maximum guaranteed number of program/erase cycles, as documented in the Official Published Specifications for the device.

Lenovo makes no representations or warranties with respect to non-Lenovo products. Support (if any) for the non-Lenovo products is provided by the third party, not Lenovo.

Some software might differ from its retail version (if available) and might not include user manuals or all program functionality.

Recycling Information

Lenovo encourages owners of information technology (IT) equipment to responsibly recycle their equipment when it is no longer needed. Lenovo offers a variety of programs and services to assist equipment owners in recycling their IT products. For information on recycling Lenovo products, go to:

<http://www.lenovo.com/recycling>

Particulate Contamination

Attention: Airborne particulates (including metal flakes or particles) and reactive gases acting alone or in combination with other environmental factors such as humidity or temperature might pose a risk to the device that is described in this document.

Risks that are posed by the presence of excessive particulate levels or concentrations of harmful gases include damage that might cause the device to malfunction or cease functioning altogether. This specification sets forth limits for particulates and gases that are intended to avoid such damage. The limits must not be viewed or used as definitive limits, because numerous other factors, such as temperature or moisture content of the air, can influence the impact of particulates or environmental corrosives and gaseous contaminant transfer. In the absence of specific limits that are set forth in this document, you must implement practices that maintain particulate and gas levels that are consistent with the protection of human health and safety. If Lenovo determines that the levels of particulates or gases in your environment have caused damage to the device, Lenovo may condition provision of repair or replacement of devices or parts on implementation of appropriate remedial measures to mitigate such environmental contamination. Implementation of such remedial measures is a customer responsibility..

Contaminant	Limits
Particulate	<ul style="list-style-type: none"> The room air must be continuously filtered with 40% atmospheric dust spot efficiency (MERV 9) according to ASHRAE Standard 52.2¹. Air that enters a data center must be filtered to 99.97% efficiency or greater, using high-efficiency particulate air (HEPA) filters that meet MIL-STD-282. The deliquescent relative humidity of the particulate contamination must be more than 60%². The room must be free of conductive contamination such as zinc whiskers.
Gaseous	<ul style="list-style-type: none"> Copper: Class G1 as per ANSI/ISA 71.04-1985³ Silver: Corrosion rate of less than 300 Å in 30 days

¹ ASHRAE 52.2-2008 - *Method of Testing General Ventilation Air-Cleaning Devices for Removal Efficiency by Particle Size*. Atlanta: American Society of Heating, Refrigerating and Air-Conditioning Engineers, Inc.

² The deliquescent relative humidity of particulate contamination is the relative humidity at which the dust absorbs enough water to become wet and promote ionic conduction.

³ ANSI/ISA-71.04-1985. *Environmental conditions for process measurement and control systems: Airborne contaminants*. Instrument Society of America, Research Triangle Park, North Carolina, U.S.A.

Telecommunication Regulatory Statement

This product may not be certified in your country for connection by any means whatsoever to interfaces of public telecommunications networks. Further certification may be required by law prior to making any such connection. Contact a Lenovo representative or reseller for any questions.

Electronic Emission Notices

When you attach a monitor to the equipment, you must use the designated monitor cable and any interference suppression devices that are supplied with the monitor.

Federal Communications Commission (FCC) Statement

Note: This equipment has been tested and found to comply with the limits for a Class A digital device, pursuant to Part 15 of the FCC Rules. These limits are designed to provide reasonable protection against harmful interference when the equipment is operated in a commercial environment. This equipment generates, uses, and can radiate radio frequency energy and, if not installed and used in accordance with the instruction manual, may cause harmful interference to radio communications. Operation of this equipment in a residential area is likely to cause harmful interference, in which case the user will be required to correct the interference at his own expense.

Properly shielded and grounded cables and connectors must be used to meet FCC emission limits. Lenovo is not responsible for any radio or television interference caused by using other than recommended cables and connectors or by unauthorized changes or modifications to this equipment. Unauthorized changes or modifications could void the user's authority to operate the equipment.

This device complies with Part 15 of the FCC Rules. Operation is subject to the following two conditions: (1) this device may not cause harmful interference, and (2) this device must accept any interference received, including interference that might cause undesired operation.

Industry Canada Class A Emission Compliance Statement

This Class A digital apparatus complies with Canadian ICES-003.

Avis de Conformité à la Réglementation d'Industrie Canada

Cet appareil numérique de la classe A est conforme à la norme NMB-003 du Canada.

Australia and New Zealand Class A Statement

Attention: This is a Class A product. In a domestic environment this product may cause radio interference in which case the user may be required to take adequate measures.

European Union - Compliance to the Electromagnetic Compatibility Directive

This product is in conformity with the protection requirements of EU Council Directive 2004/108/EC (until April 19, 2016) and EU Council Directive 2014/30/EU (from April 20, 2016) on the approximation of the laws of the Member States relating to electromagnetic compatibility. Lenovo cannot accept responsibility for any failure to satisfy the protection requirements resulting from a non-recommended modification of the product, including the installation of option cards from other manufacturers.

This product has been tested and found to comply with the limits for Class A equipment according to European Standards harmonized in the Directives in compliance. The limits for Class A equipment were derived for commercial and industrial environments to provide reasonable protection against interference with licensed communication equipment.

 Lenovo, Einsteinova 21, 851 01 Bratislava, Slovakia

Warning: This is a Class A product. In a domestic environment this product may cause radio interference in which case the user may be required to take adequate measures.

Germany Class A Statement

Deutschsprachiger EU Hinweis:

Hinweis für Geräte der Klasse A EU-Richtlinie zur Elektromagnetischen Verträglichkeit

Dieses Produkt entspricht den Schutzanforderungen der EU-Richtlinie 2014/30/EU (früher 2004/108/EC) zur Angleichung der Rechtsvorschriften über die elektromagnetische Verträglichkeit in den EU-Mitgliedsstaaten und hält die Grenzwerte der Klasse A der Norm gemäß Richtlinie.

Um dieses sicherzustellen, sind die Geräte wie in den Handbüchern beschrieben zu installieren und zu betreiben. Des Weiteren dürfen auch nur von der Lenovo empfohlene Kabel angeschlossen werden. Lenovo übernimmt keine Verantwortung für die Einhaltung der Schutzanforderungen, wenn das Produkt ohne Zustimmung der Lenovo verändert bzw. wenn Erweiterungskomponenten von Fremdherstellern ohne Empfehlung der Lenovo gesteckt/eingebaut werden.

Deutschland:

Einhaltung des Gesetzes über die elektromagnetische Verträglichkeit von Betriebsmitteln

Dieses Produkt entspricht dem „Gesetz über die elektromagnetische Verträglichkeit von Betriebsmitteln“ EMVG (früher „Gesetz über die elektromagnetische Verträglichkeit von Geräten“). Dies ist die Umsetzung der EU-Richtlinie 2014/30/EU (früher 2004/108/EC) in der Bundesrepublik Deutschland.

Zulassungsbescheinigung laut dem Deutschen Gesetz über die elektromagnetische Verträglichkeit von Betriebsmitteln, EMVG vom 20. Juli 2007 (früher Gesetz über die elektromagnetische Verträglichkeit von Geräten), bzw. der EMV EU Richtlinie 2014/30/EU (früher 2004/108/EC), für Geräte der Klasse A.

Dieses Gerät ist berechtigt, in Übereinstimmung mit dem Deutschen EMVG das EG-Konformitätszeichen - CE - zu führen. Verantwortlich für die Konformitätserklärung nach Paragraph 5 des EMVG ist die Lenovo (Deutschland) GmbH, Meitnerstr. 9, D-70563 Stuttgart.

Informationen in Hinsicht EMVG Paragraph 4 Abs. (1) 4:

Das Gerät erfüllt die Schutzanforderungen nach EN 55024 und EN 55022 Klasse A.

Nach der EN 55022: „Dies ist eine Einrichtung der Klasse A. Diese Einrichtung kann im Wohnbereich Funkstörungen verursachen; in diesem Fall kann vom Betreiber verlangt werden, angemessene Maßnahmen durchzuführen und dafür aufzukommen.“

Nach dem EMVG: „Geräte dürfen an Orten, für die sie nicht ausreichend entstört sind, nur mit besonderer Genehmigung des Bundesministers für Post und Telekommunikation oder des Bundesamtes für Post und Telekommunikation betrieben werden. Die Genehmigung wird erteilt, wenn keine elektromagnetischen Störungen zu erwarten sind.“ (Auszug aus dem EMVG, Paragraph 3, Abs. 4). Dieses Genehmigungsverfahren ist nach Paragraph 9 EMVG in Verbindung mit der entsprechenden Kostenverordnung (Amtsblatt 14/93) kostenpflichtig.

Anmerkung: Um die Einhaltung des EMVG sicherzustellen sind die Geräte, wie in den Handbüchern angegeben, zu installieren und zu betreiben.

Japan VCCI Class A Statement

この装置は、クラス A 情報技術装置です。この装置を家庭環境で使用すると電波妨害を引き起こすことがあります。この場合には使用者が適切な対策を講ずるよう要求されることがあります。
VCCI-A

This is a Class A product based on the standard of the Voluntary Control Council for Interference (VCCI). If this equipment is used in a domestic environment, radio interference may occur, in which case the user may be required to take corrective actions.

Japan Electronics and Information Technology Industries Association (JEITA) Statement

高調波ガイドライン適合品

Japan Electronics and Information Technology Industries Association (JEITA)
Confirmed Harmonics Guidelines (products less than or equal to 20 A per phase)

高調波ガイドライン準用品

Japan Electronics and Information Technology Industries Association (JEITA)
Confirmed Harmonics Guidelines with Modifications (products greater than 20 A per phase).

Korea Communications Commission (KCC) Statement

이 기기는 업무용(A급)으로 전자파적합기기로
서 판매자 또는 사용자는 이 점을 주의하시기
바라며, 가정외의 지역에서 사용하는 것을 목
적으로 합니다.

This is electromagnetic wave compatibility equipment for business (Type A). Sellers and users need to pay attention to it. This is for any areas other than home.

Russia Electromagnetic Interference (EMI) Class A statement

ВНИМАНИЕ! Настоящее изделие относится к классу А.
В жилых помещениях оно может создавать радиопомехи, для
снижения которых необходимы дополнительные меры

People's Republic of China Class A electronic emission statement

中华人民共和国“A类”警告声明

声明

此为A级产品，在生活环境中，该产品可能会造成无线电干扰。在这种情况下，可能需要用户对其干扰采取切实可行的措施。

Taiwan Class A compliance statement

警告使用者：
這是甲類的資訊產品，在
居住的環境中使用時，可
能會造成射頻干擾，在這
種情況下，使用者會被要
求採取某些適當的對策。

